

Fall 2014

# Behavior in air leakage and recirculation under the influence of booster fans

Koziba Feledi

Follow this and additional works at: [http://scholarsmine.mst.edu/masters\\_theses](http://scholarsmine.mst.edu/masters_theses)

 Part of the [Mining Engineering Commons](#)

**Department:**

## Recommended Citation

Feledi, Koziba, "Behavior in air leakage and recirculation under the influence of booster fans" (2014). *Masters Theses*. 7327.  
[http://scholarsmine.mst.edu/masters\\_theses/7327](http://scholarsmine.mst.edu/masters_theses/7327)

This Thesis - Open Access is brought to you for free and open access by Scholars' Mine. It has been accepted for inclusion in Masters Theses by an authorized administrator of Scholars' Mine. This work is protected by U. S. Copyright Law. Unauthorized use including reproduction for redistribution requires the permission of the copyright holder. For more information, please contact [scholarsmine@mst.edu](mailto:scholarsmine@mst.edu).

BEHAVIOR IN AIR LEAKAGE AND RECIRCULATION UNDER THE INFLUENCE  
OF BOOSTER FANS

By

KOZIBA FELEDI

A THESIS

Presented to the Faculty of the Graduate School of the  
MISSOURI UNIVERSITY OF SCIENCE AND TECHNOLOGY

In Partial Fulfillment of the Requirements for the Degree  
MASTER OF SCIENCE IN MINING ENGINEERING

2014

Approved by:

Dr. Stewart Gillies, Advisor

Dr. Grzegorz Galecki

Dr. Kray Davis Luxbacher



## ABSTRACT

A booster fan is an underground mechanical ventilation equipment installed in series with a main surface fan that is used to boost the air pressure provided by the surface main fan passing through it. As mining continues to expand and go deeper, the need for improved and efficient ventilation increases. This has led to the use of booster fans and other auxiliary ventilation devices in underground mines. Research defining how system leakage and recirculation are affected by booster fans; describing how system leakage and recirculation are affected by the location, placement, and amount of air pressure from the booster fans; and identifying the relationships between booster fans and main surface fans in ventilation systems that are consistent with U.S. mining conventions is presented in this study.

The objective of this thesis is to quantify and investigate the amount and behavior of ventilation leakage and recirculation that results from increased air pressure as a result of booster fan use. An airflow quantity survey and pressure differentials across stoppings were measured to investigate this behavior. The computer simulation program Ventsim Visual was used to simulate this investigation as a tool of enhancing the results obtained.

Observations were made which lead to the conclusion from the experimental analysis and computer simulation that booster fans affect the behavior of leakage and recirculation. The locations of the booster fan and the blade angle setting have the most effect on leakage and recirculation. To limit the potential for system leakage and recirculation, the location and size of a booster fan in a ventilation system should be thoroughly evaluated.

## ACKNOWLEDGEMENTS

This work would have not been possible to achieve without the helping hand extended by my committee members. I would therefore like to extend my sincerest gratitude to my advisor Dr. Stewart Gillies, and also to my tireless committee members; Dr. Grzegorz Galecki and Dr. Kray Davis Luxbacher. Jimmie Taylor, John Tyler, Mike Bassett and DeWayne Phelps; thank you for the unconditional assistance, guidance, caring, patience, and providing an excellent working environment during the use of Missouri S&T Experimental Mine. I would also like to thank Kathleen Morris for her continued assistance throughout the research.

I would also extend my deepest appreciation to NIOSH for supplying the funds which made this work a possibility and success that it was. Thank you to the University of Utah's mining department for a partnership that afforded me the opportunity to undertake this research.

Lastly, I would like to thank my mother, my brother and my sister for the constant and unwavering support. Boitumelo Nicole Lehutso, I did not give up because you would not let me.

## TABLE OF CONTENTS

	Page
ABSTRACT.....	iii
ACKNOWLEDGEMENTS.....	iv
LIST OF ILLUSTRATIONS.....	ix
LIST OF TABLES.....	xi
SECTION	
1. INTRODUCTION.....	1
1.1. BACKGROUND.....	1
1.2. PROBLEM STATEMENT.....	3
1.3. OBJECTIVE.....	4
2. LITERATURE REVIEW.....	5
2.1. BOOSTER FANS.....	5
2.2. ADVANTAGES OF BOOSTER FANS.....	6
2.3. DISADVANTAGES OF BOOSTER FAN USE.....	6
2.4. USE OF BOOSTER FANS.....	8
2.4.1. Worldwide Use.....	8
2.4.2. Use of Booster Fans in US.....	10
2.5. POTENTIAL PROBLEMS WITH USE OF BOOSTER FANS.....	15
2.6. RESEARCH IN THE US.....	16
3. EXPERIMENTAL SETUP.....	18
3.1. MISSOURI S&T EXPERIMENTAL MINE.....	18

3.2. MISSOURI S&T VENTILATION SYSTEM.....	20
3.2.1. Main Surface Fan.....	20
3.2.2. Booster Fans.....	23
3.2.3. Ventilation Path.....	30
3.2.4. Mine Stoppings and Doors.....	31
3.2.4.1. Stoppings.....	31
3.2.4.2. Doors.....	32
3.3. VENTILATION SURVEY.....	34
3.3.1. Pressure Survey.....	35
3.3.2. Air Quantity Survey.....	37
3.4. BASIC EQUATIONS RELATED TO STUDY.....	39
3.4.1. Atkinson's Equation.....	39
3.4.2. Kirchhoff's Laws.....	41
3.4.2.1. Kirchhoff's first law.....	41
3.4.2.2. Kirchhoff's second law.....	41
3.4.3. Fan Laws.....	42
3.4.3.1. Fan pressure.....	42
3.4.3.2. Airflow.....	42
3.4.3.3. Density.....	43
3.4.3.4. Air power.....	43
4. EXPERIMENTAL ANALYSIS.....	44
4.1. LEAKAGE.....	44
4.1.1. Introduction.....	44

4.1.2. Methods of Measuring Leakage through Stoppings.....	47
4.1.2.1. Brattice window method.....	49
4.1.2.2. Averaging method.....	51
4.1.2.3. Airflow difference before and after stopping.....	54
4.1.3. Leakage at Missouri S&T Experimental Mine.....	54
4.1.3.1. Scenario 1: Main fan only.....	57
4.1.3.2. Scenario 2: Main fan and the east booster fan.....	59
4.1.3.3. Scenario 3: Main fan and the west booster fan.....	65
4.1.3.4. Scenario 4: Main fan, east and west booster fan.....	69
4.2. RECIRCULATION.....	71
4.2.1. Measuring Recirculation at Missouri S&T Experimental Mine.....	74
4.2.2. Calculating Recirculation.....	75
4.2.3. Scenario 1: Main Fan Only.....	75
4.2.4. Scenario 2: Main Fan and the East Booster Fan.....	76
4.2.5. Scenario 3: Main Fan and the West Booster Fan.....	77
4.2.6. Scenario 4: Main Fan, East and West Booster Fans.....	77
4.3. CONCLUSION TO SECTION.....	78
5. VENTSIM VISUAL SIMULATION ANALYSIS.....	80
5.1. VENTSIM VISUAL.....	80
5.2. MISSOURI S&T EXPERIMENTAL MINE VENTILATION SYSTEM.....	82
5.2.1. Scenario 1: Main Fan Only.....	86
5.2.2. Scenario 2: Main Fan and the East Booster Fan.....	89
5.2.2.1. Main fan and the east booster fan at blade setting 1.....	90



5.2.2.2. Main fan and the east booster fan at blade setting 3.....	92
5.2.2.3. Main fan and the east booster fan at blade Setting 5.....	93
5.2.3. Scenario 3: Main Fan and West Booster Fan.....	94
5.2.3.1. Main fan and the west booster fan at blade setting 1.....	95
5.2.3.2. Main fan and the west booster fan at blade setting 3.....	96
5.2.3.3. Main fan and the west booster fan at blade setting 5.....	97
5.2.4. Scenario 4: Main Fan, West Booster and East Booster Fan.....	100
5.2.4.1. Main fan, west booster and east booster fan at blade setting 1.....	100
5.2.4.2. Main fan, west booster and east booster fan at blade setting 3.....	102
5.2.4.3. Main fan, west booster and east booster fan at blade Setting 5.....	104
5.3. CONCLUSION TO SECTION .....	106
6. CONCLUSIONS AND RECOMMENDATION.....	108
6.1. CONCLUSIONS.....	108
6.2. RECOMMENDATIONS.....	111
BIBLIOGRAPHY.....	113
VITA.....	118

## LIST OF ILLUSTRATIONS

	Page
Figure 3.1 Missouri S&T Experimental Mine aerial view.....	19
Figure 3.2 Kennedy portal.....	19
Figure 3.3 Wheeler portal.....	20
Figure 3.4 Missouri S&T surface main fan.....	21
Figure 3.5 Missouri S&T surface mine main fan curve.....	22
Figure 3.6 Missouri S&T surface main fan ventilation system elbow.....	23
Figure 3.7 Fan blade angle configurations.....	24
Figure 3.8 Booster fan locations.....	25
Figure 3.9 Bulkhead construction.....	26
Figure 3.10 Booster fan bulkhead- front view.....	26
Figure 3.11 Booster fan bulkhead- rear view.....	27
Figure 3.12 Variable frequency drive.....	28
Figure 3.13 Booster fan curve.....	29
Figure 3.14 Airflow directions within Missouri S&T Experimental Mine.....	30
Figure 3.15 Kennedy steel stoppings as installed in the mine.....	32
Figure 3.16 Kennedy steel door.....	33
Figure 3.17 Kennedy machine doors.....	34
Figure 3.18 Anemometer traverse.....	38
Figure 4.1 Leakages vs. number of stoppings.....	46
Figure 4.2 TTS installed in a mine entry.....	49

Figure 4.3 Standard method for measuring average stopping leakage.....	52
Figure 4.4 Map showing stoppings where leakage was measured.....	56
Figure 5.1 Pressure survey stations.....	83
Figure 5.2 Mine airway parameters.....	85
Figure 5.3 Main mine fan profile.....	86
Figure 5.4 Mine main fan only simulation results.....	87
Figure 5.5 Leakage across stopping 3 due to the main fan.....	88
Figure 5.6 East booster fan profile.....	89
Figure 5.7 Main fan and east booster fan at blade set 1 simulated results.....	91
Figure 5.8 Main fan and east booster fan at blade set 3 simulation results.....	92
Figure 5.9 Main fan and east booster fan at blade set 5 simulation results.....	94
Figure 5.10 West booster fan profile.....	95
Figure 5.11 Main fan and west booster fan at blade set 1 simulated results.....	96
Figure 5.12 Main fan and west booster fan at blade set 3 simulated results.....	97
Figure 5.13 Main fan and west booster fan at blade set 5 simulated results.....	99
Figure 5.14 Main fan, west and east booster fans at blade set 1 results.....	101
Figure 5.15 Main fan, west and east booster fan at blade set 3 results.....	103
Figure 5.16 Recirculation and leakage on the east part of the mine.....	105
Figure 5.17 Recirculation and leakage on the west part of the mine.....	106

## LIST OF TABLES

	Page
Table 4.1 Main fan quantity survey.....	57
Table 4.2 Pressures differentials across stoppings due to main fan.....	58
Table 4.3 Leakage due the main fan and east booster fan.....	60
Table 4.4 Pressure differences across stoppings due to main and east booster fan.....	62
Table 4.5 Leakage due the main fan and west booster fan.....	66
Table 4.6 Pressure differences across stoppings due to main fan and west booster fan....	67
Table 4.7 Leakage due the main fan, east and west booster fans.....	70
Table 5.1 Pressure quantity survey results.....	84

## 1. INTRODUCTION

### 1.1. BACKGROUND

Mine ventilation is and has always been a very critical part of any underground mine. Adequate air quantity is required for an environment that is conducive for workers, for the dilution of poisonous and noxious gases, for the dilution of diesel exhaust fumes, and for cooling or heating of the mine environment. As the mine gets deeper and moves farther from ventilation shafts, the need for efficient ventilation practices increase. Advances in better and more efficient equipment have resulted in faster work area advances, liberating more dust, gas, heat and as a result, worker health and safety requirements in the face area have become more stringent. For all these reasons the safety and efficiency of any underground mine depends heavily on its ventilation.

As mining continues to expand and go deeper, the need for improved and efficient ventilation increases. With this increase in ventilation needs, overall mining operating costs also increase. This increase is mostly associated with the need to increase the required fan pressure and air quantity to overcome increased resistance. There is also increased leakage as the growth or expansion of the mine generates more leakage paths. This has led to the use of booster fans and other auxiliary ventilation devices in underground mines. The use of booster fans in coal mines can be traced back to as early as 1905 in Hulton Colliery, United Kingdom. In general, the use of booster fans in metals, non-metal mines and coal mines has been applied worldwide. However, the United States prohibits the use of booster fans in coal mines. This is clearly stated in MSHA's code of regulations (30 CFR § 75.302, 2010);

“Each coal mine shall be ventilated by one or more main mine fans. Booster fans shall not be installed underground to assist main mine fans except in anthracite mines. In anthracite mines, booster fans installed in the main air current or a split of the main air current may be used provided their use is approved in the ventilation plan.”

Recirculation can be defined as the movement of mine ventilation air past the same point more than once (Jones, 1987). Recirculation is generally classified into two categories: controlled recirculation, where a limited and known quantity of air is deliberately passed from the return airways to the intake airways, and uncontrolled recirculation, where a quantity of air is leaked from the return airways to the intake airways unintentionally (Wempen, 2012). The use of controlled recirculation of air in mines is not a new concept. Probably the first use of deliberate recirculation in British collieries dated back to the early 1930s where it was used to improve comfort level in hot workings (Lawton, 1933). Although fundamental principles were established over thirty years ago (Bakke, Leach, and Slack, 1964; Leach, 1969) and the first large-scale controlled recirculation system was applied in a coal mine around that time (Robinson, 1972), extensive research and field applications did not get started until the late 1970s and early 1980s.

Controlled partial recirculation of ventilation air provides an alternative to costly ventilation measures. Instead of including the flow rate of fresh intake air, recirculation enables airflow rates to be increased locally, the rate of temperature increase to be substantially decreased and bulk air coolers to be used for cooling entire areas. Although there are benefits associated with recirculation, there is a notable risk: recirculation has the potential to increase the contaminant concentration in intake air. If recirculation is

well controlled, the concentration of contaminants in intake air can be managed, but if recirculation is uncontrolled, there is the potential for contaminants to build up in the intake air, potentially forming a hazardous mine atmosphere (Wempen, 2012).

## **1.2. PROBLEM STATEMENT**

Booster fans have the potential to be a safe means of enhancing the capacity of a ventilation system and increasing the overall system efficiency. Since the prohibition of booster fans in the United States in the 1980s, there has been limited research about booster fan ventilation systems and controlled recirculation in underground coal mines. Additionally, because booster fans are accepted as a safe and effective means of ventilating coal mines in other developed mining countries including Australia and the United Kingdom, current research about the use of booster fan ventilation systems is limited. For booster fans to be considered for use in underground coal mines in the United States, current research about the effects of booster fans on ventilation systems is needed.

Although there are similarities among the mining technologies and practices in the United States, the United Kingdom, and Australia, there are legal and practical dissimilarities that have caused each country to approach coal mine ventilation differently. Practices that contribute to the safe use of booster fans in the United Kingdom and Australia need to be identified and evaluated to determine the applicability of these practices to U.S. coal mines. Increasing the capacity and efficiency of a ventilation system is one of the main motives for using booster fans, but as the efficiency of the system is increased by the use of booster fans, recirculation is more likely to occur.

In fact, many ventilation systems that use booster fans experience a significant amount of recirculation. Most underground coal mines in the United Kingdom rely on booster fans and recirculation to provide adequate air quantities and velocities; however, in the United States, recirculation is not an accepted ventilation practice. Methods to limit recirculation in ventilation systems using booster fans need to be evaluated.

Research defining how system leakage and recirculation are affected by booster fans; describing how system leakage and recirculation are affected by the location, placement, and amount of air pressure from the booster fans; and identifying the relationships between booster fans and main surface fans in ventilation systems that are consistent with U.S. mining conventions is presented in this study.

### **1.3. OBJECTIVE**

Since leakage and recirculation are connected, the objective of this paper is to quantify and investigate the amount and behavior of ventilation leakage and recirculation that result from increased air pressure as a result of booster fan use. The placement and location of the booster fan is used to demonstrate the effect of booster fans on the amount of leakage and recirculation with regard to location of stoppings in relation to distance from the fans. A comparison between the leakage and recirculation caused by the use of the main fan only and the use of booster fans is also drawn. With the use of the computer simulation program Ventsim Visual, this comparison can be modeled.



## 2. LITERATURE REVIEW

### 2.1. BOOSTER FANS

A booster fan is an underground mechanical ventilation device installed in series with a main surface fan that is used to boost the air pressure provided by the surface main fan passing through it. Booster fans increase air pressure to overcome resistance, the objective being to force adequate amounts of air through distant workings. They are used in areas that are difficult or uneconomic to ventilate with main fans alone (Martikainen and Taylor, 2010).

A booster fan is installed to overcome mine environmental conditions in which the surface fan is physically incapable of providing the airflow requirements or when these requirements can only be fulfilled at extremely high pressures which cause excessive air leakage. It is usually located in the return airway to avoid problems that may result from the use of airlocks in haulage roadways. Stoppings of superior construction enable the fan to operate safely and free of recirculation.

The electrical motor and control devices are generally placed in intake air to eliminate any possibility of electrically igniting methane. However some mines have them placed in return air when an enclosed fan motor is used. Furthermore, fan operating conditions need to be continuously evaluated by means of a remote monitoring and control system. According to British Standards, the system must be arranged to shut down the fan automatically if the methane content in the air passing through the fan reaches 1.25 %, or if any abnormal condition is detected (Saxton, 1987).

## 2.2. ADVANTAGES OF USING BOOSTER FANS

Booster fans are not ideal for every ventilation situation but when they are properly sized and located, they have the capacity to provide improvements in various underground environments. According to (Calizaya et al., 1988; Calizaya et al., 1990; McPherson, 2009), booster fans can be used to:

- Help with the improvement of airflow distribution within the mine's difficult-to-ventilate areas.
- Improve flow rates in high-resistance circuits.
- Facilitate the availability of air to areas with difficult surface conditions.
- Minimize the air pressure differentials between intake and return airways.
- Reduce the severity of leakage between intake and return airways.
- Reduce the overall power costs associated with ventilation.
- Keep the development costs at a minimum.
- Decrease the amount of main fan pressure required for air to reach the working areas.
- Prevent smoke from entering intake airways during mine fires.

## 2.3. DISADVANTAGES OF BOOSTER FAN USE

When an underground coal mine gets to be older or larger, the severity of short circuiting fresh air increases through leakage paths. The required high pressure

differentials required to move air to faces can lead to considerable air flow losses through stoppings. Moll and Lowndes (1994) surmised that air leakage in a mine can be controlled by the addition of pressure sources such as the use of underground booster fans

A 2003 MSHA proposed decision and order (PDO) regarding a petition to allow the use of a booster fan in an underground bituminous coal mine lists a few disadvantages for booster fan use in underground mine. These safety concerns are mostly associated with underground explosions and mine fires and they include (Langton, 2003).

- The use of booster fans can reduce the ability to control recirculation of air underground.
- The opportunities to restore ventilation to some areas in the mine are limited when the main mine fan is not functioning.
- Ventilation will be interrupted if electricity in the vicinity of the booster fan is interrupted.
- The ability to adjust ventilation to some specific areas is limited during fires or explosions.
- Booster fans have the ability to increase noise, respirable dust and float coal mine dust levels.

Calizaya et al. (1990) and Brake and Nixon (2006) also discuss some disadvantages that can also be looked at which include:

- Development of difficulties when there is a stoppage of main fan/booster.

- The use of booster fans brings about complexity to the ventilation system and its management.
- The inappropriate use of a booster fan which will likely result in increased ventilation related operating costs.

## 2.4. USE OF BOOSTER FANS

**2.4.1. Worldwide Use.** The utilization of booster fans in underground mines has been long established throughout the history of underground mining industry. This can all be traced as far back as the early 1900's in the United Kingdom. Calizaya et al. (1988) reported that Alfred Tonge discussed the use of booster fans that were used as far back as 1905 in Hulton Colliery. A Coal Mine Act of 1911 in UK established the use of booster fans in British coal mines while having a main fan on the surface. This in turn facilitated an improvement in working conditions and as a result, a drop in British fatal explosions from 23 in 1911 to six in 1919 was observed (Saxton, 1986). Booster fans have been in regular use in British coal mines since the first half of the twentieth-century but had not been widely accepted or used until after the nationalization of coal mines in 1947. Since then, a focused need to improve standards of ventilation and mining ventilation was observed and more resources were directed towards such. A comprehensive approach to ventilation surveys and planning, together with the realization of the benefits of booster fans, led to their more rapid introduction.

Many coal mines in the U.K. are at moderate depth and have virgin strata temperatures of 30°C or less. The ability to control climatic conditions by increased ventilation rather than resorting to cooling systems has led to the introduction of booster

fans and recirculation systems in these mines. Large makes of methane and high levels of coal dust production due to increased mechanization have also required enhanced ventilation standards.

Australian mines depend on the independent states for mine safety regulations as each state has its own regulations. Martikainen et al. (2010) reports that the large underground coal operations in Australia with possible interest in booster fans are located in Queensland and New South Wales. In Queensland, according to Queensland Consolidated Regulations (2001);

“At least one methane monitor must be located near the fan to warn workers if concentrations exceed 1.25% and to shut the fan down if concentrations exceed 2.0%. Standard procedures for each fan include procedures to be followed when the fan activates an alarm. In addition to monitoring the fan’s static pressure, mine operators must be sure to continuously monitor other fan operating conditions. Only specifically designated persons are permitted to start, stop or alter the fan.”

Martikainen et al. (2010) also goes on to explain that the legislation of New South Wales (New South Wales government, 2006) states;

“The operator of an underground mine must ensure that any auxiliary ventilation fan used in the underground parts of a mine is located and operated in such a manner as to prevent recirculation of air through the fan.”

In South Africa, the regulations that are designated for the use of the main fan are also applied towards the booster fans. These requirements include monitoring and early warning of defective operations. The requirements also allow for every booster fan to be examined for effective operation at intervals not exceeding three months. Power supply

requirements provide that there has to be two different sources of power for the fans. Booster fan installation and operation has to follow a written procedure prepared and implemented for that purpose (van Zyl, 2008).

Federal regulations in Canada are no longer in effect. Instead, individual Canadian provinces have regulations concerning booster fans. Current and potential underground coal mining operations are located in British Columbia, Alberta and Nova Scotia (Bonnell, 2008).

**2.4.2. Use of Booster Fans in US.** According to the United States Federal Register (1992), booster fans are permitted in metal and nonmetal mining, as well as in anthracite coal mines.

As early as the 1920s', the US discouraged the use of booster fans without specifically banning them but discouraging them. This is shown by a list of demerits against the use of booster fans from a 1927 meeting in New York as recorded by Smith and Washington (1927);

- Booster fans will recirculate air if there are any leaky stoppings, overcasts or doors between the intake and return airways on the suction side of the fan or if there is loose construction in the fan housing.
- Where air is recirculated there is an undesirable decrease in the percentage of oxygen and an increase in the percentage of methane in the ventilating current. The former reduces the amount of work which men and animals can perform, and the latter is a hazard to the lives of the men in the mine.
- Auxiliary fans will recirculate air when the volume of air passing through the entry is not in excess of that passing through the auxiliary fan, and

they may recirculate air when the current is in excess of that passing through the fan. Auxiliary fans will always recirculate air when the fan is in by the last open crosscut.

- Booster and auxiliary fans are not desirable as regards either economical operation or safety when used to offset the defects of leaky stoppings and doors, or as a substitute for properly maintained air courses.
- Booster and auxiliary fans driven by electricity have ignited gas and have caused mine fires and gas explosions, resulting in loss of life and property.
- In the event of a mine fire a booster fan may interfere seriously with or may aid in getting the fire under control.
- When ventilation is dependent upon a booster fan and at the time of an explosion the fan cannot be operated by reason of being wrecked or the power being shut off, the recovery of the mine is seriously retarded and the hazards of the rescue crew and of any survivors of the explosion are greatly increased.

Smith and Washington (1927) surmised that commentators at the meeting objecting to prohibiting the use of boosters indicated that regulations could be developed under which analysis, justification and approval for the installation of boosters can be permitted. Such regulations may also include specific monitoring, ventilation surveying and record-keeping requirements.

They also point out that some commentators cited the long-standing practices and experiences abroad with booster fans in coal mines. Others felt that the advancements in

mine ventilation, as well as in automatic monitoring and remote control technology, have made possible a greater degree of safety than was possible some two decades ago.

According to Martikainen et al. (2010), the 1969 Act and regulations did not prohibit the use of booster fans in underground coal mines. The act made requirements of main fans on the surface that hindered the use of booster fans underground. Martikainen et al. (2010) continues to point out that in 1989, MSHA published proposed coal mine ventilation rules which were meant to revise and update the existing ones. The 1989 regulations and the final rule in 1992 prohibited the use of booster fans in bituminous and lignite coal mines. Reasons cited by MSHA include existing approval criteria, the established industry practice, and several safety concerns associated with such issues as recirculation, fires, fan control, noise and dust.

Restricting the use of booster fan use minimizes the ability of a mine to be flexible in its design and operation. Martikainen et al. (2010) argues that with the increase in depths and breadths of coal seams, the ability to design a ventilation system for such a mine becomes difficult. She also points that it would be difficult for any valuable research to be made without approval of booster fans in underground mines on an experimental basis.

Section 101 of the Federal Mine Safety and Health Act of 1977 provides an opportunity for a mine to petition the Secretary of Labor so as to modify the application of a mandatory safety standard. Since then, there have been two petitions filed by mine operators to use booster fans in underground bituminous mines. Both petitions were rejected by MSHA.



In 1985, Jim Walter Resources Inc. (JWR) determined its No. 7 Mine in Alabama required additional ventilation capacity. It then submitted a detailed plan to MSHA that specified a Jeffrey fan equipped with a 745 kW direct drive motor located in the main intake. The projected fan capacity was 300 m<sup>3</sup>/s at 1992 Pa. The main reason for the proposal being rejected was mainly due to the flow recirculation through the fan. The proposal was revised to eliminate the danger of flow recirculation, the fan capacity decreased to 151 m<sup>3</sup>/s at 1071 Pa. Two years later, the project was rejected mainly due to lack of expertise in the mining industry to evaluate the performance of these fans.

18 years later on September 5, Consolidation Coal Company filed its own petition for modification of its Loveridge No 22 Mine in Marion County, West Virginia. MSHA personnel investigated the petition and reported their findings and recommendations to the Administrator for Coal Mine Safety and Health. Below is an exact from the MSHA response (Langton, 2003);

“Section 75.302 serves to protect main mine fans from fires and damage so that in the event of an underground explosion ventilation can be maintained. Booster fans reduce the ability to control recirculation of air underground. Also, if an underground main mine fan is damaged; booster fans limit opportunities to restore ventilation to specific areas. If it is necessary to remove electricity from an area, ventilation can be interrupted. A fire or explosion can make it impossible to travel underground or to control the booster fan so that ventilation can be adjusted in specific areas of the mine. Booster fans can also increase noise and respirable float coal mine dust levels. Finally, reliance on the use of a booster fan can reduce awareness of the impact on overall mine ventilation when the fan is switched on and off between the winter and summer months.

MSHA's investigation determined that the auxiliary slope fan is used to improve or augment ventilation in a segment of the mine. Consequently, the auxiliary slope fan is a booster fan. Simulations demonstrated that major ventilation changes occur if the auxiliary slope fan is inoperative. When the auxiliary slope fan stops, ventilation is reversed and the intake at the Sugar Run Shaft decreases by 25 m<sup>3</sup>/s. When the auxiliary slope fan is operating, six seals at 3-North Crossover and ten seals at Main North are ventilated with less than 0.47 m<sup>3</sup>/s. These changes constitute major ventilation changes.

Although the alternative method includes installing the auxiliary slope fan in a fireproof housing and installing an automatic fire suppression system, the auxiliary slope fan is installed underground and remains vulnerable to damage from a major mine fire or explosion. The proposed alternative method includes installation of devices to monitor temperature, vibration, water, and operational status from the surface; however, no independent power circuit is installed and it is impossible to start or stop the auxiliary slope fan from the surface. The major ventilation changes which MSHA's investigation determined occur when the fan is idled or starting have not been addressed. Although the proposed alternative method would include daily examination of the auxiliary slope fan, the alternative method does not provide a means, such as the installation of mechanical airtight doors at the bottom of the slope, to protect the auxiliary slope fan from wrecks. Finally, the alternative method provides no means of reducing ventilation pressure generated by the auxiliary slope fan on the long chute loaded track area seals."

A mine fire accident occurred at the Loveridge Mine on February 13, 2003. MSHA's accident report details how the auxiliary slope fan which is the subject of this petition greatly hampered firefighting efforts. The recirculation caused by the auxiliary

slope fan, its inaccessibility, and its danger of being rendered inoperable by the fire were significant factors in losing control of the fire. As a result, the mine had to be evacuated and subsequently was sealed.

For the reasons described above, MSHA has concluded that the alternative method proposed by the Petitioner would not at all times guarantee no less than the same measure of protection afforded the miners under 30 CFR 75.302.

On the basis of the petition and the findings of MSHA's investigation, Consolidation Coal Company is not granted a modification of the application of 30 CFR 75.302 to its Loveridge No. 22 Mine.

## **2.5. POTENTIAL PROBLEMS WITH USE OF BOOSTER FANS**

Potential hazards of increased likelihood of mine fires and recirculation of contaminants are introduced when booster fan is not selected or installed adequately. In the history of utilization of booster fans, two major accidents that claimed lives are reported: the Auchengeich Colliery fire in Scotland (1959), and the Sunshine Mine fire in Idaho (1972). In the first case, the belt drive on the booster fan caught fire. The fire spread to the roadway timber and claimed the lives of 43 workers. The workers died from carbon monoxide poisoning. Since then, the use of Vee-belt drives underground has been severely restricted (Robinson, 1989). In the second case, the mine was ventilated by four booster fans installed in series. According to the U.S. Bureau of Mines, the probable cause of the fire was spontaneous combustion of scrap timber used to backfill worked out stopes. By the time the fire was detected, the smoke had already filled the main haulage way and the intake raises and active stopes located on lower levels. The fans contributed

to the propagation of smoke into the working inbye the fire. Among other factors for this incident were: failure to provide the fans with remote control, failure to monitor the mine atmosphere for carbon monoxide, and delay in starting the evacuation of personnel. As a result, 91 men died of carbon monoxide poisoning (Jarret, 1972).

## 2.6. RESEARCH IN THE US

Multiple researches have been carried out to investigate the potential use of booster fans in US underground coal mines. According to Martikainen et al. (2010), Virginia Polytechnic Institute and State University studied the optimization of multiple fan systems that included booster fans. They developed a critical path-crashing technique that optimized multiple fan ventilation systems with booster fans. Wu and Topuz (1987, 1989) describe other techniques, like linear programming, the out of- kilter method and the network simplex method.

Martikainen et al. (2010) further points out that the largest effort to study booster fans in the U.S. was performed under a grant from the U.S. Bureau of Mines in 1985. This study focused a great deal on the extensive survey on the use of booster fans. The results showed that 318 booster fan installations were located in underground coal mines worldwide. This study also covered the attitudes toward the use of booster fans in the coal mining industry of the U.S. was conducted. The findings showed that 42% of the coal mines were interested in installing booster fans, 52% considered the risk of recirculation to be the primary reason for not taking an interest in using booster fans and only 6% pointed out other primary reasons (McPherson et al., 1985).

Calizaya et al. (1987) expanded the study to include booster fans and regulators at fixed locations and to minimize the overall power consumption VNETPC and MFSELECT software were used to determine the fans and regulators that would fulfill the airflow requirements of a mine and minimize the total power consumption. NIOSH has been funding research programs in Universities aimed at investigating the use of booster fans in the U.S.

### 3. EXPERIMENTAL SETUP

This section identifies the setup of the ventilation survey experiment used to determine the effect on the behavior of leakage and recirculation due to the use of booster fans. Included are: procedures, equipment, mine structure and characteristics, and equations related to the study.

#### 3.1. MISSOURI S&T EXPERIMENTAL MINE

The Missouri S&T Experimental Mine is one of only a few such facilities available on a university campus for mining engineering education purposes. The facility is used primarily by the students and faculty of MST's department on mining and nuclear engineering for instruction and research in mining engineering and geological engineering practices. The mine also serves as an introduction to the mining industry in Missouri for the public through guided tours and various informational programs.

It consists of two underground mines and two small quarries on a 76890 m<sup>2</sup> site. It is staffed by two full-time employees and a variety of mining equipment is available for instructional and research purposes. Although no commercial ores have been found on the property, veins of "fool's gold" (an iron sulfide mineral) frequently have been discovered during underground mining operations. Figure 3.1 shows the aerial view of the mine as of May 2014 while Figure 3.2 and 3.3 show the Kennedy portal and Wheeler mine portal respectively.



Figure 3.1 Missouri S&T Experimental Mine aerial view



Figure 3.2 Kennedy portal



Figure 3.3 Wheeler portal

### 3.2. MISSOURI S&T VENTILATION SYSTEM

**3.2.1. Main Surface Fan.** Missouri S&T Experimental Mine uses a Joy manufacturing axial vane series 1000 (Figure 3.4) blowing fan as the main fan. The fan is a 1.08 m diameter fan that is driven by a 22 kW motor with a capacity to blow  $25\text{m}^3/\text{s}$  of airflow at 1000 Pa of static pressure. It has a running speed capacity of 1750 rpm with a two speed configuration. The current blade setting for the main fan is 8 and this can be read from the fan performance curve in Figure 3.5. A 15 m long steel pipe is connected to the fan and has an overall diameter of 1.14 m. The round ventilation tubing is then connected to a  $1\text{ m}^2$  square pipe that is 1.5 m long. From the fan house, air passes through a retractable  $90^\circ$  elbow (Figure 3.6) which constitutes a substantial loss of air pressure. The measured airflow at the bottom of the shaft is  $19\text{ m}^3/\text{s}$ .





Figure 3.4 Missouri S&T surface main fan

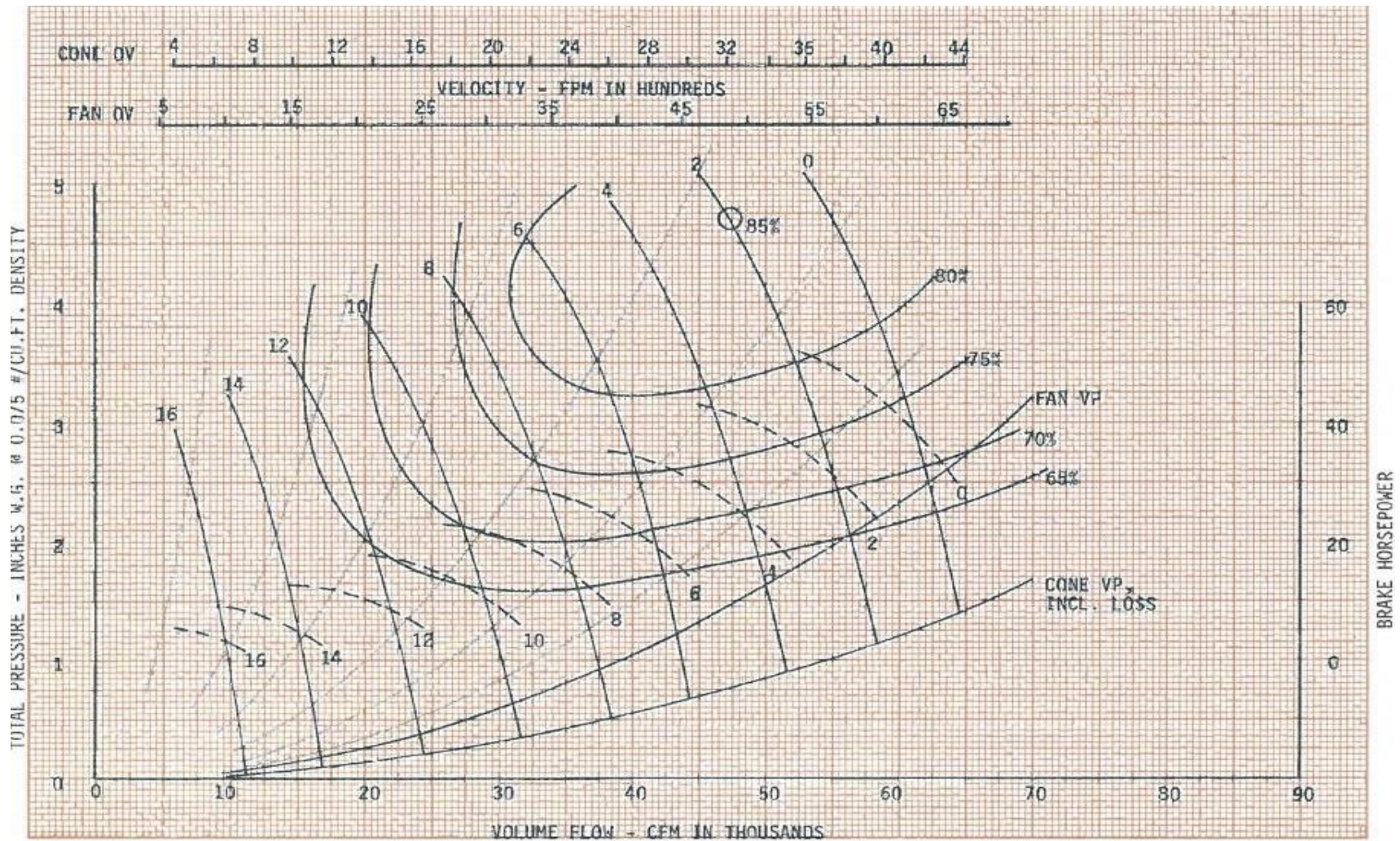

AUGUST 11, 1950  
C-1288

JOY SERIES 1000 AXIVANE FAN  
MODEL 42½-17-1770

Figure 3.5 Missouri S&T surface mine main fan curve



Figure 3.6 Missouri S&T surface main fan ventilation system elbow

**3.2.2. Booster Fans.** The Missouri S&T Experimental Mine uses two Spendrup series booster fans, both 112-040-1200-A-1D type of fan. These are high performance, variable pitch, vane axial fans. The fans run on 11.2 kW motor, have a maximum speed of 1200 revolutions per minute and have a measured capacity to produce 17.9 m<sup>3</sup>/s of airflow at the highest blade setting (blade setting 5). The booster fans have a six blade angle configuration as shown in Figure 3.7, which can be adjusted manually. One fan is located at the eastern end of the mine while the other is located at the western part of the mine on the return airways. This is shown on the map in Figure 3.8. Bulkheads are constructed with man doors at each booster fan to control recirculation. The bulkheads are constructed from Kennedy stoppings with poly-urethane and cementitious mixture

used to reduce leakage as shown in Figure 3.9. Figure 3.10 and Figure 3.11 show different bulkheads arrangement at both fans with different Kennedy steel doors sizes. The fan speed is manually controlled from a separate variable frequency drive control box which allows for adjustments while the fan is running and it is shown in Figure 3.12. A booster fan curve used for both booster fans is represented in Figure 3.13.

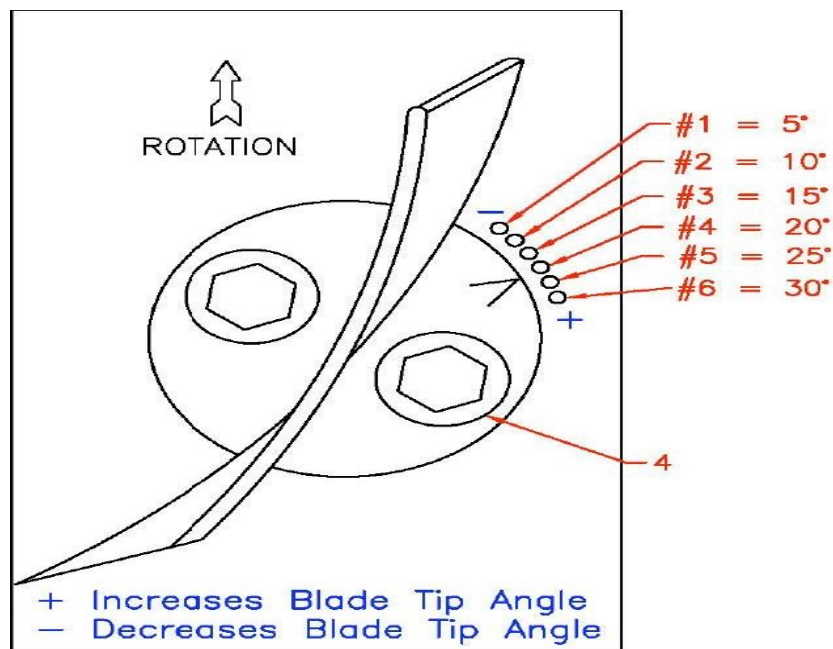

Figure 3.7 Fan blade angle configurations

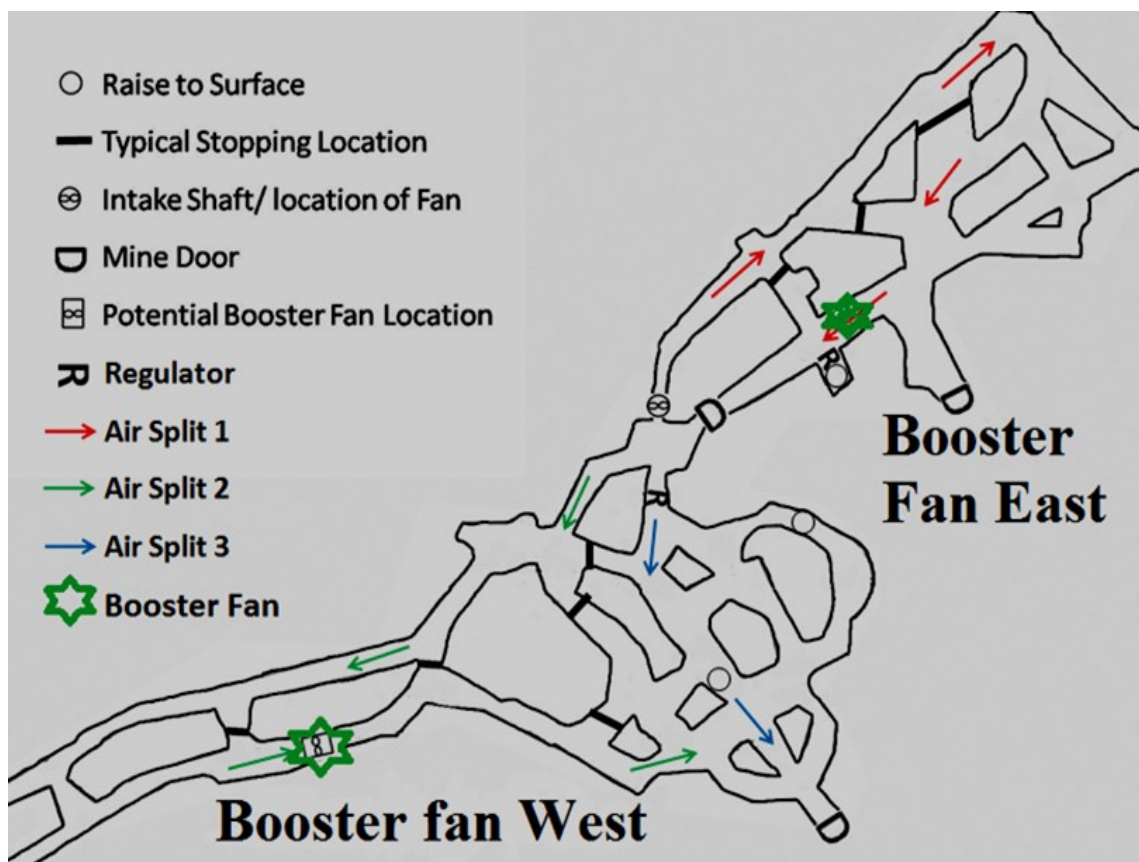

Figure 3.8 Booster fan locations

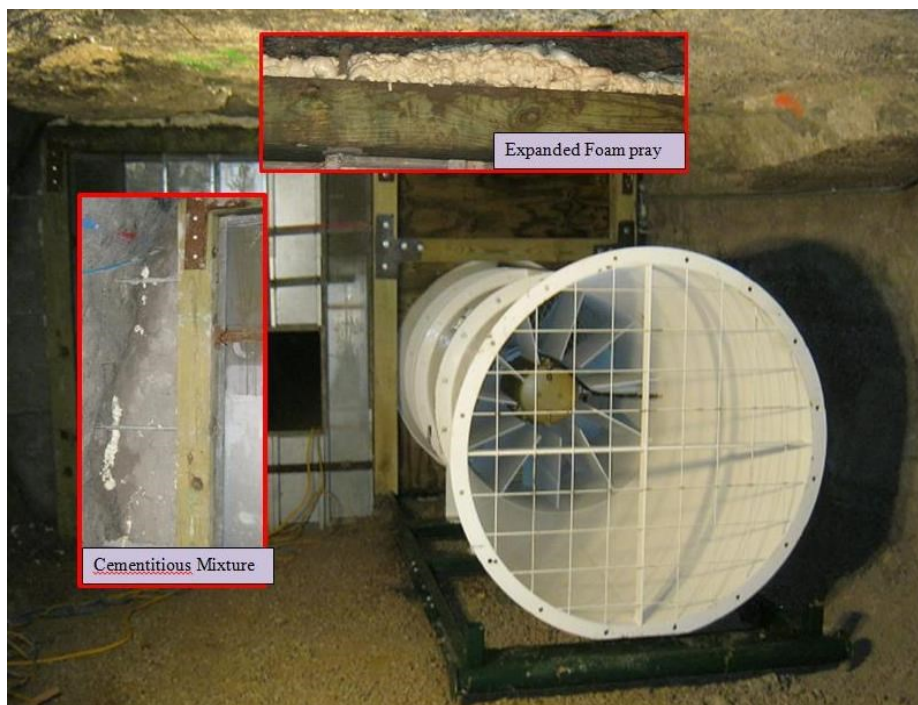

Figure 3.9 Bulkhead construction



Figure 3.10 Booster fan bulkhead- front view



Figure 3.11 Booster fan bulkhead- rear view



Figure 3.12 Variable frequency drive





**Series 112-040-1200-A-1**

Fan Diameter 44 Inches  
Air Density 0.075 lbs./cu. ft.

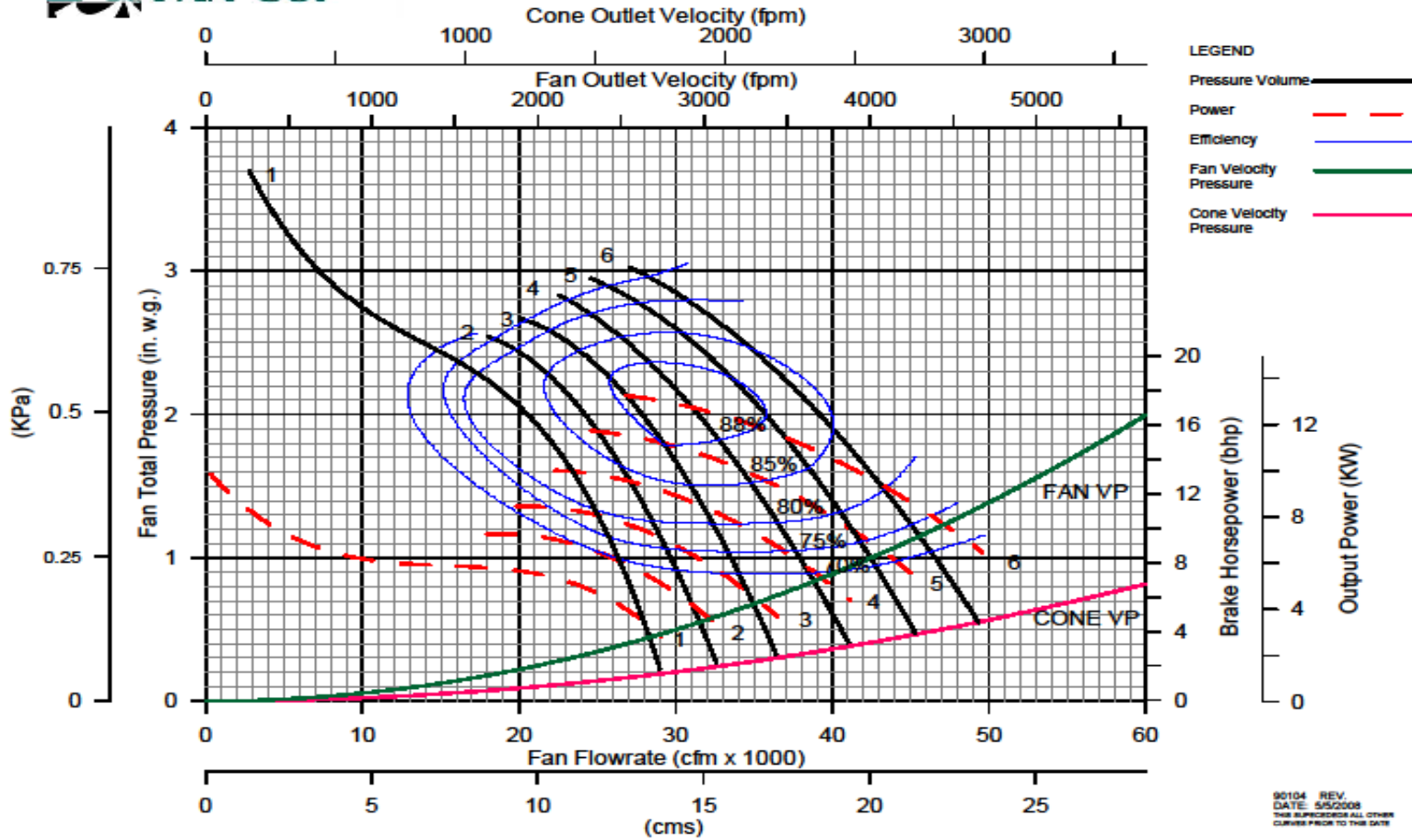

Figure 3.13 Booster fan curve

**3.2.3. Ventilation Path.** The Missouri S&T Experimental Mine consists of two shafts, one serving as the intake shaft and the other to serve as an exhaust for the new upgraded system. Air is pulled in through the main shaft by a Joy Manufacturing axial vane fan and follows the direction shown on the map on Figure 3.14. The air is currently exhausted through the Wheeler portal. Dolomite makes up the most rock type in Missouri S&T mine and the ventilation airways are characterized by roughly to average blasted airways. The mine also consists of; three raises which are either fully or partially blocked, two portals with one acting as an exhaust and the other closed by a hydraulic Kennedy door.

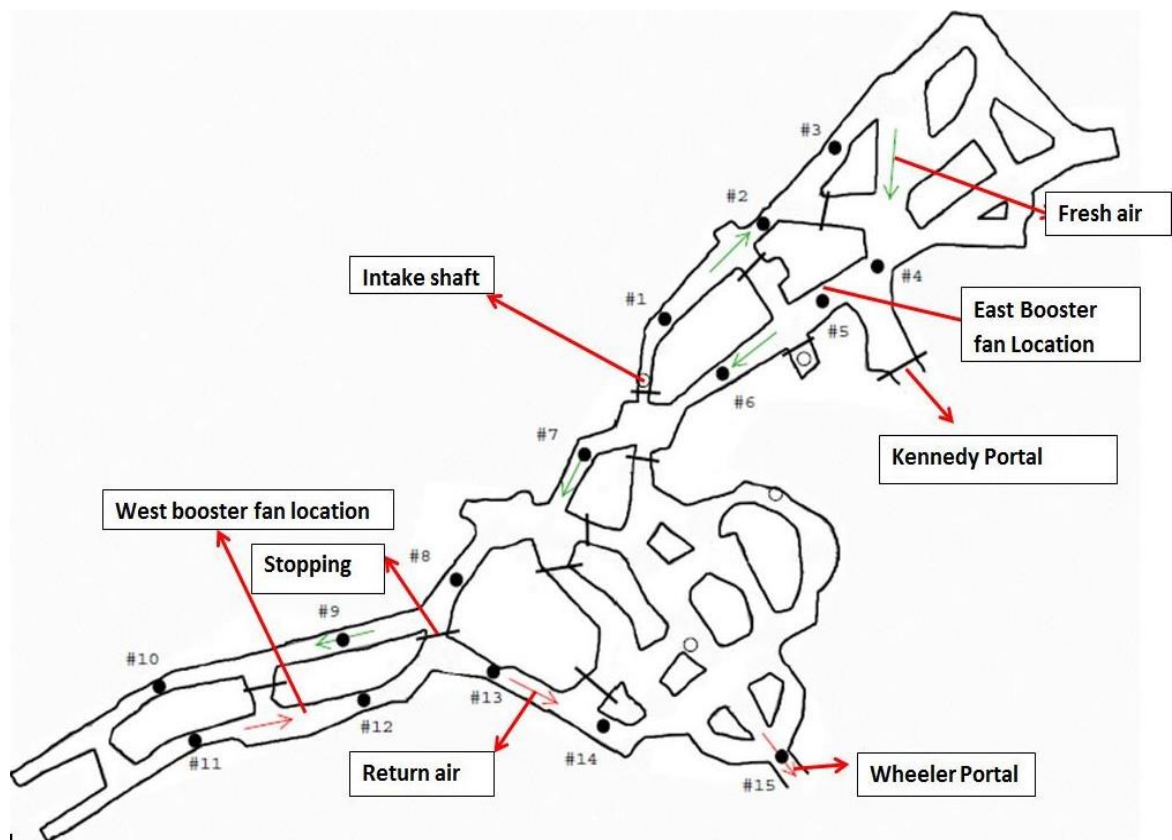

Figure 3.14 Airflow directions within Missouri S&T Experimental Mine

**3.2.4. Mine Stoppings and Doors.** Missouri S&T Experimental Mine ventilation system consists of doors and stoppings to control and direct the movement of airflow throughout the system.

**3.2.4.1. Stoppings.** A system of Kennedy yielding steel stoppings is used throughout the mine to temporarily assist in directing airflow. A Kennedy standard steel stopping is a system of half a meter vertically telescoping steel panels, installed under pressure in an entry to form a substantial and incombustible airtight permanent stopping. Each panel is actually two panels-one inside the other- forming an upper and lower unit. Upon installation, these two panels are telescoped apart to reach the roof from the floor of the mine. The telescoping action of the Kennedy steel stopping is to yield to heaving, as well as bow out to accommodate pillar expansion (Anon, 2010). The stoppings are made such that they are fire proof, either through conduction or radiation. To minimize stopping leakage, polyurethane foam was used. In addition, duct tape was also used to mask the gaps between the stoppings to make the stoppings as airtight as possible. Figure 3.15 illustrates a stopping made from Kennedy steel stopping panels and sealed with polyurethane and duct tape.



Figure 3.15 Kennedy steel stoppings as installed in the mine

**3.2.4.2. Doors.** The types of doors used in the Experimental Mine are Kennedy steel man doors and Kennedy steel machine doors. The man doors are made with galvanized steel and are built for Kennedy steel stoppings. A Kennedy door and Kennedy stopping panel arrangement can be seen in Figure 3.16. The doors seal on the outside of their frame. The pressure that would normally be found on the frame of a man door in a conventional stopping is absorbed by the telescopic action of the upper and lower short panels in the Kennedy stopping. Consequently, air leakage is held to a minimum over the stopping's life. A Kennedy "D" rubber seal is used to seal tight against the channel frame and minimize any leakages.

The Kennedy machine doors have been made with enduring strength due to possible underground mine heaving and distortion conditions. The Kennedy machine doors are designed to respond to the inordinate pressures of convergence to keep the doors working. The designs for the machine door also include gapless seals and heavy duty “dee” rubber seals. These help the door to successfully handle the ventilating pressure loads of underground mining. The Kennedy machine doors used at Missouri S&T Experimental Mine are shown in Figure 3.17.



Figure 3.16 Kennedy steel door



Figure 3.17 Kennedy machine doors

### 3.3. VENTILATION SURVEY

Analysis of an existing mine ventilation system, including the evaluation of modifications to the system, requires accurate input data that can be developed only by a data pressure-quantity survey in the mine (McElroy and Kingery, 1957). The purposes of an accurate underground pressure survey are to obtain a pressure gradient along the circuit and determine the values of friction factor for various types of airways. A ventilation survey is an organized procedure of acquiring data that quantify the distributions of airflow, pressure and air quality throughout the main flow paths of a ventilation system that requires detailed and precise measurement (Javanbakht, 2013).

As mentioned previously, mine pressure and quantity surveys are undertaken to gain an understanding of mine characteristics in total and in particular airflow characteristics through sections of a mine. Complete ventilation surveys are performed periodically or at random times for the following reasons (Hartman et al. 1997):

- To obtain knowledge of the extent and adequacy of the existing ventilation system in meeting specific needs, standards and regulations.
- To provide information for use in emergencies or disasters underground, such as fires, explosions, major cave-ins or floods.
- To plan for improvement of current environmental conditions or efficiency of existing ventilation system.
- To make provisions for mining extension or modifications, new fan installations, changes in airways or circuits and new air shafts.

Pressure survey data is required in particular:

- To enable modification and expansion of ventilation circuits to be planned.
- To isolate critical zones of high pressure loss and high friction factor to enable improvement in network efficiency.

**3.3.1. Pressure Survey.** Pressure measurements in underground mines can be made on either an absolute or differential basis. Measurements made on an absolute basis at each station are subtracted one from the other to find the pressure loss between stations. For the purpose of this study the differential pressure measurement method has

been used. In this method a precision pressure sensors is to be used to measure the difference between the pressures applied to two different stations.

There are two methods of conducting pressure surveys.

- Direct method: Rubber tubing or hose is laid between the two points between which pressure difference is to be measured. A precision pressure sensor is then connected either at one end or at some other convenient point along the tube. The manometer reading is the pressure difference between the two points.
- Indirect Method: uses a pair of precision pressure sensors which are used for obtaining the pressure difference between any two points in an airway. Since they indicate only the absolute static pressure at a point, the difference in pressure must be calculated from adjacent readings rather than read directly.

In conducting a survey using the indirect method, either of two methods may be used, both requiring two instruments. The first method is called the “leapfrogging method”, where both instruments are taken underground and read simultaneously at adjacent stations. The preceding instrument is the advancing instrument for each successive measurement. Both instruments are adjusted to the same reading at each station, and with simultaneous readings with the aid of synchronized watches, the effect of atmospheric-pressure changes is eliminated. Since readings at each station are also duplicated, the results are more accurate.



The second method is the single-base method where one instrument is used underground in making the traverse while the second one remains on the surface or at some base point underground. Readings at both are taken on a prearranged time schedule. A recording precision pressure sensor can also be used for the base instrument. Three corrections to altimeter data (atmospheric pressure changes, velocity differences, and elevation differences) are necessary to calculate the pressure (Hartman, 1992).

For this study, the single base method was used, where one instrument was outside the mine and the other traversed through different underground locations.

**3.3.2. Air Quantity Survey.** The vast majority of air velocity measurements made manually underground are gained from a rotating vane (windmill type) anemometer. When held in a moving airstream, the air passing through the instrument exerts a force on the angled vanes, causing them to rotate with an angular velocity that is closely proportional to the airspeed. A gearing mechanism and clutch arrangement couple the vanes either to a pointer which rotates against a circular dial calibrated in meters or to a digital counter.

The anemometer should be attached to a rod of at least 1.5m in length, or greater for high airways. The attachment mechanism should permit the options of allowing the anemometer to hang vertically or to be fixed at a constant angle with respect to the rod. An anemometer is fairly insensitive to yaw and will give results that do not vary by more than  $\pm 5$  percent for angles deviating by up to  $30^\circ$  from the direction of the airstream.

For precise work, anemometer readings may be further corrected for variations in air density:

$$u = u_i + C_c \sqrt{\frac{\rho_c}{\rho_m}} \quad (3.1)$$

Where

$u$  = corrected velocity (m/s)

$u_i$  = indicated velocity (m/s)

$C_c$  = correction from instrument calibration curve or chart

$\rho_c$  = air density at time of calibration ( $\text{kg/m}^3$ )

$\rho_m$  = actual air density at time of measurement ( $\text{kg/m}^3$ )

In order to establish the truest velocity of the airway, the anemometer is traversed as shown in Figure 3.18. This insures that traversing covers most parts of the airway hence giving a true velocity representation of the area.

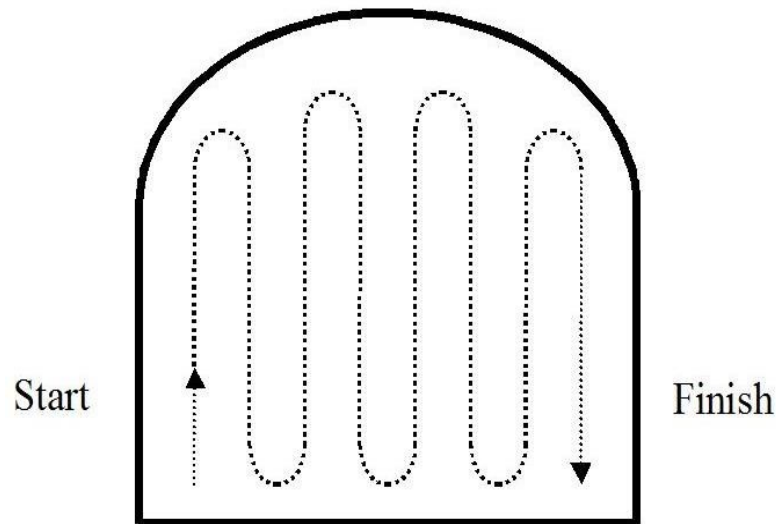

Figure 3.18 Anemometer traverse

### 3.4. BASIC EQUATIONS RELATED TO STUDY

A couple of questions were used as a baseline for the research and also as guidelines for the analysis of the research. These are discussed below;

**3.4.1. Atkinson's Equation.** Dynamically, mine ventilation systems are treated almost exclusively as systems of incompressible fluid flow and are described most often through Atkinson's equation (Wempen, 2012), commonly given by:

$$\Delta p = \frac{KO(L+L_e)Q^2}{A^3} \quad (3.2)$$

Where

$\Delta p$  = pressure difference, Pa

$K$  = friction factor,  $\text{kg/m}^3$

$O$  = perimeter, m

$L$  = length, m

$L_e$  = equivalent length to account for shock losses, m

$A$  = cross-sectional area,  $\text{m}^2$

$Q$  = volumetric flow rate,  $\text{m}^3/\text{s}$

$$\frac{KO(L+L_e)}{A^3} \quad (3.3)$$

Equation 3.3 is used as a representation of resistance,  $R$ , with units of  $\text{Ns}^2/\text{m}^8$ . The resistance of the airway is dependent of the airway dimension and the friction factor,  $K$ . The friction factor can be determined through experimentation based on a pressure-quantity survey or past research which has defined friction factor values for each different type of airway. In mine ventilation,  $K$  is assumed constant for a given airway, regardless of the Reynolds number. This is only an approximation, and on occasion the error can be sizeable (Falkie, 1958).

The volumetric flow rate of an airway is calculated by:

$$Q = VA \quad (3.4)$$

Where

$Q$  = volumetric flow rate,  $\text{m}^3/\text{s}$

$V$  = velocity,  $\text{m}/\text{s}$

$A$  = cross-sectional area,  $\text{m}^2$

The accuracy of the calculated  $Q$  is dependent on the accuracy of the measured or calculated  $V$  and  $A$  (Hartman et al. 1997). To obtain such accuracies, the use of suitable instruments and following the set procedures are fundamental requirements. Highly irregular airways with irregular surfaces tend to reduce the accuracy of the calculated  $Q$  as their areas are not easy to determine. A number of special techniques have been developed to determine such areas.

**3.4.2. Kirchhoff's Laws.** Both Kirchhoff laws were used as a guideline for the analysis part of the thesis as they are the basis for understanding airflow.

**3.4.2.1. Kirchhoff's first law.** The fundamental laws governing the behavior of electrical circuits can be extensively applied to ventilation circuit analysis as the analogy is similar for fluid flows. According to Kirchhoff's first law, also known as Kirchhoff's current law (KCL), the quantity of air leaving a junction must equal the quantity of air entering a junction (Hartman, 1997). Since the air density at a single junction in underground ventilation systems is negligible, the law can be stated as:

$$\sum Q=0 \quad (3.5)$$

Where

$$Q = \text{Volumetric flow rate, (m}^3/\text{s)}$$

**3.4.2.2. Kirchhoff's second law.** Also known as Kirchhoff's voltage law (KVL), it states that the algebraic sum of the pressure drop (change) around any closed ventilation circuit must be zero, having taken into account the effects of fans and ventilating pressures. Natural ventilation pressure can work with the ventilation system as a positive or negative pressure source (McPherson, 1993). The Kirchhoff's second law can be written as:

$$\sum p_i - p_f \pm p(n) = 0 \quad (3.6)$$

Where

$p_i$  = pressure difference in  $i$ th branch of a closed circuit, (kPa)

$p_f$  = pressure increase due to fan, (kPa)

$p(n)$  = natural ventilation pressure, (kPa)

These terms are all based on the same (standard) value of air density; this is normally  $1.2 \text{ kg/m}^3$ .

**3.4.3. Fan Laws.** Fan laws are used to predict the behavior and operating characteristics of a fan using different variables other than head-quantity conditions from characteristic curves. These laws help test the results gained from prototypes to larger fans that are geometrically similar. The following are fan laws according to (McPherson, 1993), which are based on Euler's equation and other relationships:

**3.4.3.1. Fan pressure.**

$$P \propto \rho n^2 d^2 \quad (3.7)$$

Where

$P$  = total fan pressure ( $\text{m}^3/\text{s}$ )

$\rho$  = fluid density ( $\text{kg}/\text{m}^3$ )

$n$  = rotational speed

$d$  = impeller diameter

**3.4.3.2. Airflow.**

$$Q \propto n d^3 \quad (3.8)$$

Where

$Q$  = quantity of airflow

### 3.4.3.3. Density.

$$P \propto \rho \quad (3.9)$$

Volume flow,  $Q$ , is readily accepted instead of mass flow as the basis of flow measurement in fans.

### 3.4.3.4. Air power.

$$P_{ow} \propto \rho n^3 d^5 \quad (3.10)$$

Where

$P_{ow}$  = airpower

These fan laws are applicable to compare the performance of a given fan at changed speeds or densities, or to compare the performance of different sized fans provided that those fans are geometrically similar (McPherson, 1993).

## 4. EXPERIMENTAL ANALYSIS

### 4.1. LEAKAGE

**4.1.1. Introduction.** According to Hartman et al. (1997), leakage can be defined as the unintended losses of air directly to the return from the intake. Leakages occur through structures that are intended to control the movement of air underground such as stoppings, doors and overcasts. The leakage of air does not serve an advantage to the mine ventilation system as leaked airflow does not ventilate the working areas. Fugitive air losses as a result of poorly maintained stoppings and overcasts will cause shortage of fresh air at working sections where workers need more fresh air and where the major job of diluting and carrying away gases and dusts is conducted. Furthermore, in order to compensate for these losses, additional air has to be handled at the fan. This will not only cause dust problems in airways due to higher velocities within the ventilation system, but will also increase power costs and also the health and safety standard of the mine is lowered as a result.

Hartman et al. (1997) points out that leakage through stoppings, doors, and regulators depend not only on the pressure across the control device but also on the condition of the device itself. All control devices are subject to natural deterioration over time. This may be due to the convergence of strata, blasting underground or by vehicles running into stoppings and overcasts. Hartman et al. (1997) continues to make an observation that the majority of air leakages in underground coal mines are happening at



or near the bottom of the slope where the pressure differential is the highest; the control devices are the oldest.

Air leakage in underground mines commonly varies between 25–90% (McPherson, 1993) but with improved mining conditions of today, leakage has decreased such that 40-60% of air quantity measured at the fans reaches the working face. Other researchers have observed that in coal mines, air leakage averages over 50% (Richardson et al., 1997) whereas in metal mines, leakage is typically 30% or less (Calizaya et al., 2001, Van der Bank, 1983). Kharkar et al. (1974) studied the behavior of leakage across stoppings under different airflow conditions. A Graph was plotted for leakage and it is shown in Figure 4.1, where it was surmised that;

- The rate of air loss is variable over the length of airway,
- The largest values of leakage being measured farthest from the working face with three-quarters of the total loss occurring in the first half of the intake.

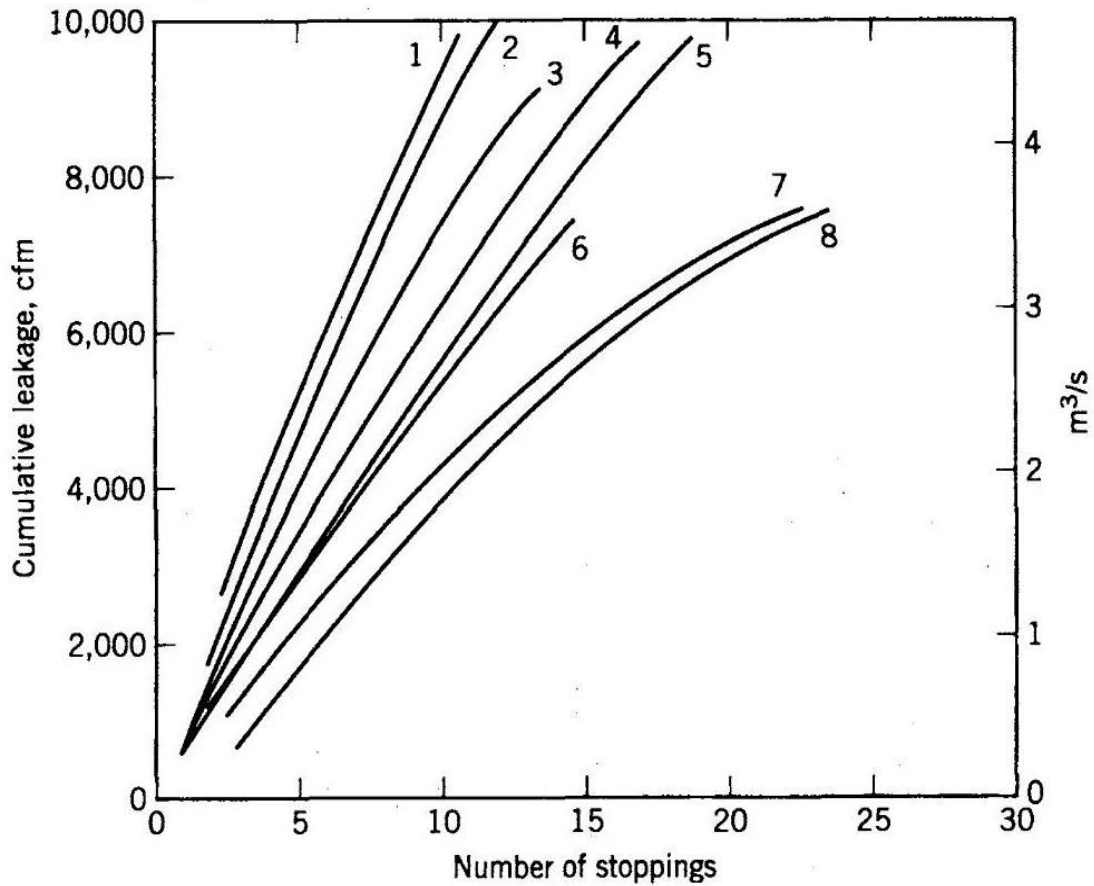

Figure 4.1 Leakages vs. number of stoppings. (Kharkar et al., 1974)

Kawenski et al. (1963), Kharkar et al. (1974), Coetzer (1985), and Tien (1996) made a few observations with regard to ventilation leakages in underground mines. The observations are as follows:

- It is not uncommon for underground coal mines to have 50-60% overall leakage.
- Leakage losses are significantly higher in the vicinity of the fan.

- Generally 75% of the total leakage occurs in the first half of the mine workings (halfway between the fan and the active workings).
- As much as 80% of the mine air leakage may happen in the vicinity and within a 610 m radius of the fan shaft.
- The pressure differential across a stopping has the greatest influence on leakage through it.
- Air leakage is significantly reduced by coating a stopping with sealant.
- Leakages are not the same in every mine.

**4.1.2. Methods of Measuring Leakage through Stoppings.** As early as 1931, Briggs attempted to characterize leakage through a stopping by using a “porosity coefficient” concept:

$$Q = F(ZL, l) ( F(P_1 + P_2,2)), \quad (4.1)$$

Where

Q = amount of leakage

$F(P_1 + P_2,2)$  = pressure differential across stopping line

Z = porosity

L= length

L= thickness

The concept states that the amount of leakage is directly proportional to the pressure difference across the stopping line, the porosity, length, and thickness of the

stopping line. Mancha (1942) proposed a hypothesis that equated the ratio of the pressure loss with and without leakage as being proportional to the ratio of the air quantities at the two points in a ventilation circuit. This was validated by Peascod and Keane (1955) by finding out that the quantity of loss is a function of distance, with the greatest loss occurring in the section furthest away from the working face. Holdsworth, et al. (1951) surmised that the first half of the airway contributed to 75 per cent of the total loss.

A comprehensive study was carried out by Kawenski and Mitchell (1965 & 1966), which characterized the relationship between the amount of leakage through a stopping, pressure differential across the stopping, and two other constants; (a) and (n). The relationship was represented as such:

$$Q = aH^n \quad (4.2)$$

Where

Q = amount of leakage (m<sup>3</sup>/s)

H = pressure differential across the stopping (Pa)

a = air leakage at a set pressure differential

n = air passing through crevices

There are many accepted methods that are regarded as standard for measuring leakage across stoppings. Leakage can be measured directly across each individual stopping or indirectly through multiple stoppings. The individual method is very time consuming but shows a true representation of each stopping while the indirect method is

usually reversed for large underground mines and reflects the average leakage of the mine.

**4.1.2.1. Brattice window method.** This method uses the concept of leakage through a stopping by determining the amount of such leakage through the use of the Brattice Window Method as described by Vinson et al. (1977):

A second stopping, called the temporary test stopping (TTS), is erected in the same entry as the leaking permanent stopping (see Figure 4.2). The TTS is made of an impervious fabric, such as plastic mine brattice, and is fastened to the roof, floor, and sides of the entry with spads or similar fasteners. The TTS also will leak, as air will pass through gaps around the edges. A rectangular opening, window 1, is cut into the TTS.

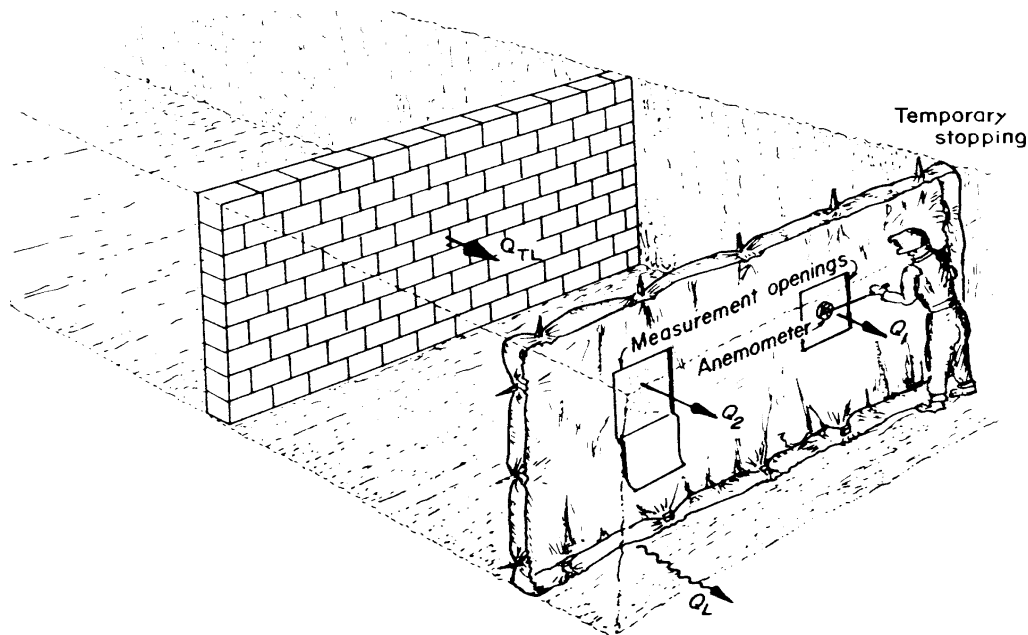

Figure 4.2 TTS installed in a mine entry (Vinson et. al 1977)

The cross-sectional area of this window and the velocity of air passing through it are measured and the volume flow calculated from:

$$Q_1 = V_1 A_1, \quad (4.3)$$

Where

A = cross-sectional area of window,

V = air velocity through window,

Q = air volume through window

Next, a second rectangular opening, window 2, is cut into the TTS. Its area,  $A_2$  and the velocity of air through it  $V_2'$  are measured and used to calculate the air volume  $Q_2'$  through it.

$$Q_2' = V_2' A_2, \quad (4.4)$$

The decreased air velocity  $V_1'$  through window one is also measured (while leaving Window #2 open) and a new lower air volume  $Q_1'$  is calculated from

$$Q_1' = V_1' A_1 \quad (4.5)$$

These values are used in the brattice-window-method equation to calculate the total volume of air  $Q_{TL}$  in cfm passing through the permanent stopping as follows:

$$Q_{TL} = 0.82 \left[ Q_1' + Q_2' + \frac{Q_1' + Q_2' - Q_1}{V_1/Q_1 - 1} \right] \quad (4.6)$$

The 0.82 window correction factor is necessary because of the vena contracta created by the airflow through the windows.

$$\frac{Q_1' + Q_2' - Q_1}{V_1/Q_1' - 1}$$

The last term of the equation,  $\frac{Q_1' + Q_2' - Q_1}{V_1/Q_1' - 1}$ , is the "leakage" term which gives the total volume of air leaking around the TTS.

**4.1.2.2. Averaging method.** The other method is to measure the average leakage through a group of stoppings as described by Stephens (2011):

This method is illustrated in Figure 4.3, which depicts a cut out of a coal mine section having 5 entries. Entries 1 and 2 have intake air, Entries 4 and 5 have return air, and Entry 3 has neutral air. The air courses are separated by stopping lines which periodically contain doors. Entry 3 has systematic box-check regulators to limit the neutral airflow quantity. The total intake flow is the combined measurements in Entries 1 and 2. If airflow measurements are made at section points A and B in the intake air course, the difference between A and B is the amount of intake air leaking through five stoppings into Entry 3. Pressure differentials between Entries 2 and 3 can easily be measured at the stoppings containing doors, yielding the average pressure differential across these five stoppings.

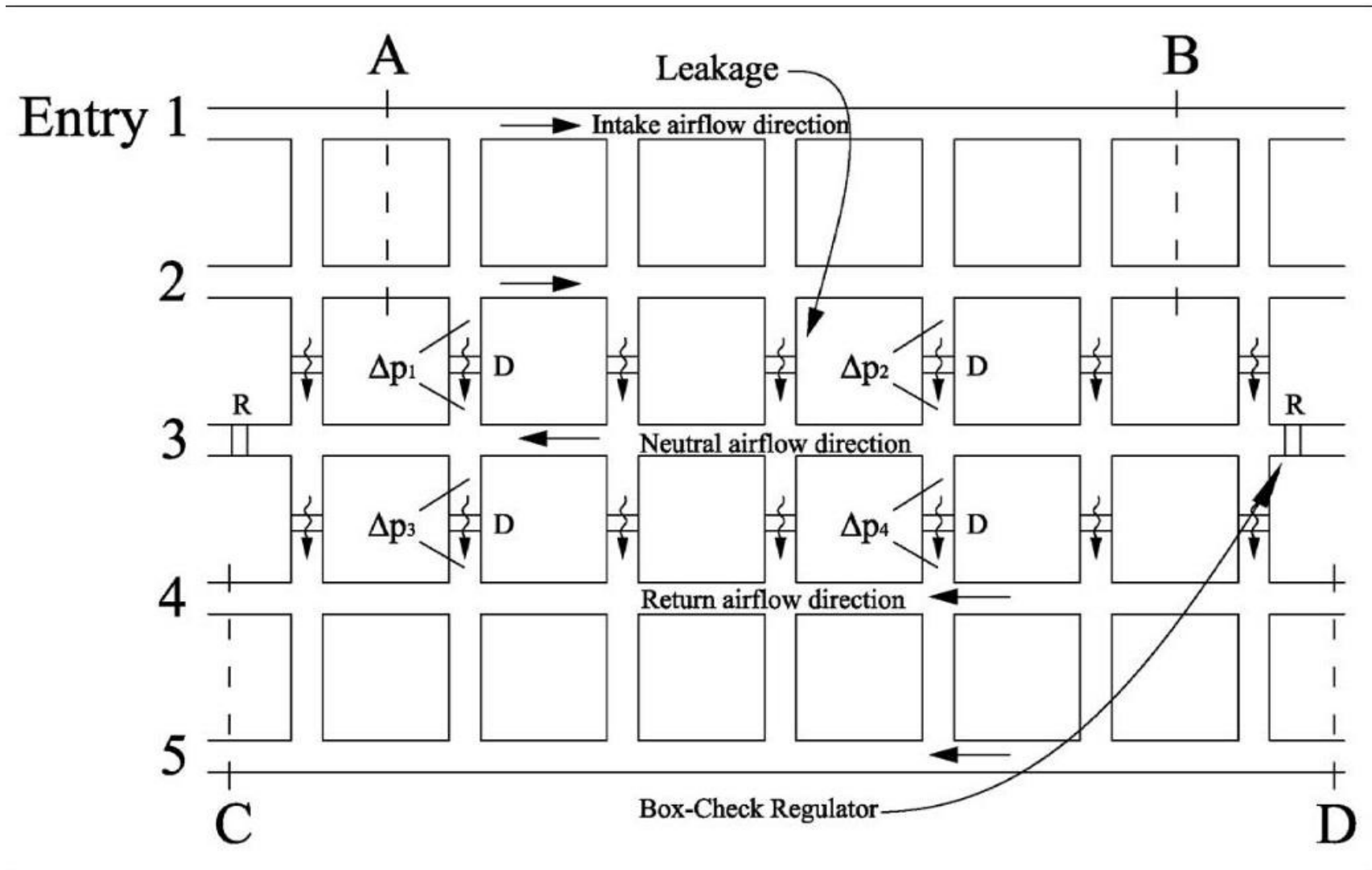

Figure 4.3 Standard method for measuring average stopping leakage



If the same method is used on the return side between points C and D the measurements yield the leakage through 7 stoppings. In both cases, Equation ( $\Delta p = RQ^2$ ) can be used to quantify an equivalent resistance for the number of stoppings, and the individual stopping resistance is calculated using Equation  $Re = R_i / N_a^2$  where  $N_a$  is 5 for the intake side stoppings and 7 for the return side.

$$\text{Square law of mine ventilation} = \Delta p = RQ^2 \quad (4.7)$$

Where

$$R = \text{airway resistance (Ns}^2/\text{m}^8)$$

$$\text{Equivalent resistance } Re = R_i / N_a^2 \quad (4.8)$$

Where

$$R_i = \text{resistance of a single airway (Ns}^2/\text{m}^8)$$

$$N_a = \text{the number of parallel airways}$$

Using this method assumes that the leakage quantities through all the stoppings in a particular group  $Q_i$ , are equal ( $Q_i = Q / N_a$ ) which is not necessarily the case. For example, stoppings with doors generally allow greater leakage than those without. This assumption may be valid over short intervals where the differential pressure across the stoppings does not vary significantly, but it is not justified over longer intervals with high variance in differential pressures. This method is not intended to distinguish resistances between individual stoppings, but rather to determine an average resistance for a group of stoppings. The preferred interval is different for each mine and depends on the pillar dimensions, as well as stopping characteristics. This method provides the ability to

measure resistance throughout a large mine relatively quickly while still being able to distinguish between groups of stoppings differing in age, condition, and type.

**4.1.2.3. Airflow difference before and after stopping.** This method was used in this study to measure leakage across a stopping. It relies on the difference in air quantity measured before and after a stopping and neglects other losses due to resistance of shock. A simple mathematical equation 4.9 summarizes the whole concept:

$$Q_b - Q_a = \Delta Q \quad (4.9)$$

Where

$Q_b$  = Quantity measured before stopping ( $m^3/s$ )

$Q_a$  = Quantity measured after stopping ( $m^3/s$ )

$\Delta Q$  = Quantity of leakage ( $m^3/s$ )

Equation 4.9 is based on Kirchhoff's first law, meaning that the quantity measured before the stopping should be equal to the quantity measured after the stopping. The distance before or after the stopping where measurements are taken is not standard but rather expected to be not less than 1.5 meters.

**4.1.3. Leakage at Missouri S&T Experimental Mine.** Air quantity measurements were taken at the Missouri S&T Experimental Mine using the method described in Section 4.1.2.3 to measure the quantity of leakage. These measurements were taken at individual stoppings throughout the mine, including in the return airways. A calibrated anemometer was used to measure the airflow velocity and a tape measure used to measure the airway dimensions. The map in Figure 4.4 shows the stoppings at

which leakage measurements were taken. In order to draw a fairly reasonable and in-depth conclusion, a number of different scenarios were experimented on. These included either the main fan running alone or coupled with one of the booster fans or both of the booster fans. Also the booster fan blade angles were varied to have a sizable difference in the amount of pressure from the booster fan. The main fan speed was maintained to a maximum at all times throughout the experiment since the emphasis of the study was on booster fans. Varying the speed of the main fan would introduce an unwanted variable in the data. Leakage through the Kennedy machine doors was not taken into consideration. For all the scenarios tested, the integrity of the stoppings was maintained to the highest possible standard. The stoppings were sealed for any excessive leakage after every test run and every booster fan blade angle change.

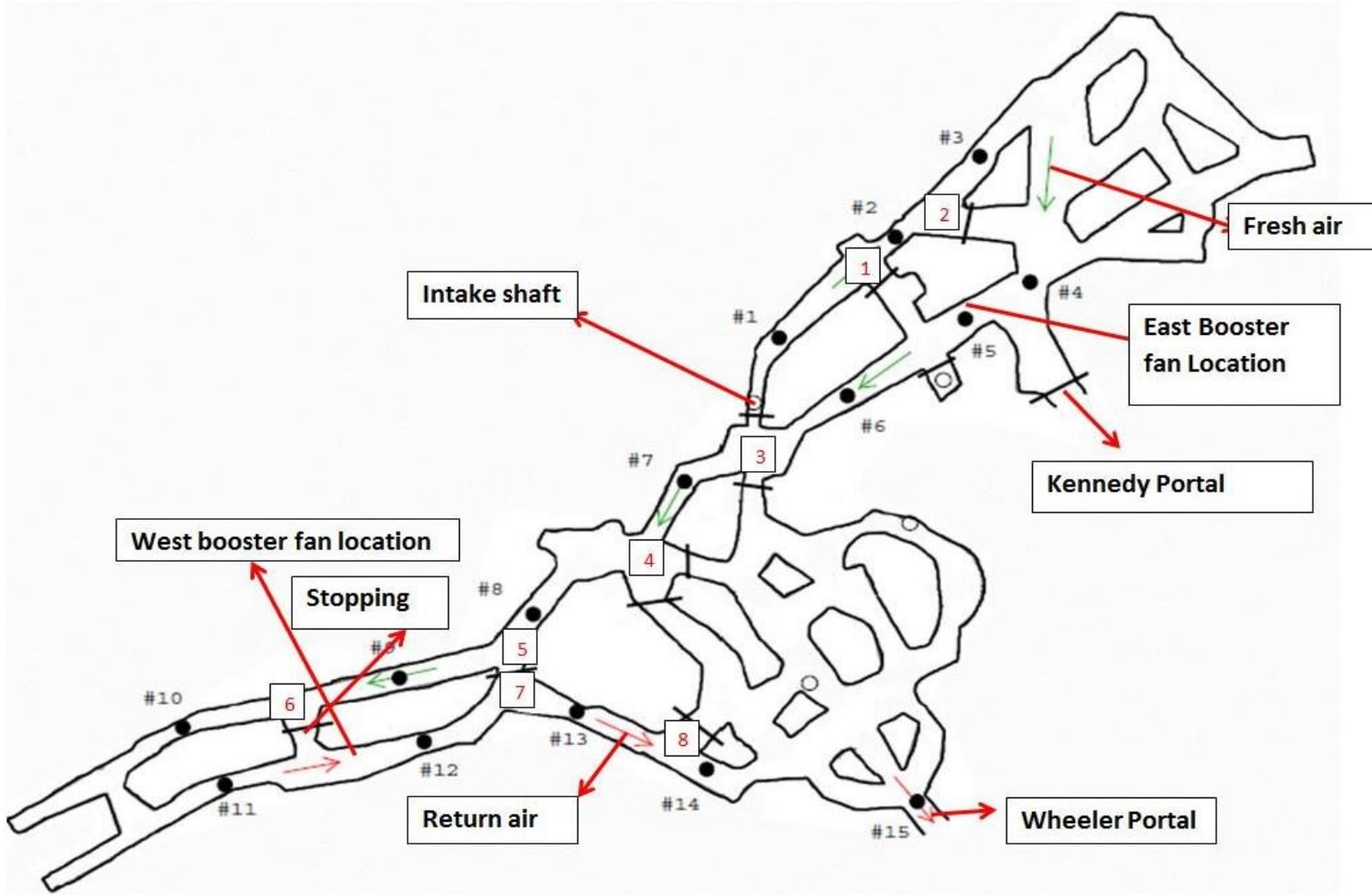

Figure 4.4 Map showing stoppings where leakage was measured

**4.1.3.1. Scenario 1: Main fan only.** This test involves the measuring of airflow quantity provided by the Missouri S&T main mine fan only. The mine main fan was run at blade angle setting 8. The results are detailed in Table 4.1 and show either leakage or recirculation at each station. Using the airflow difference before and after stopping equation ( $Q_b - Q_a = \Delta Q$ ), the  $\Delta Q$  indicates leakage across a stopping. The positive difference shows leakage from the intake into the return. In this scenario, the negative difference shows leakage from the intake into the return. In this scenario, the negative difference reflects the probability of leakage from the other side of the stopping which means there is more quantity after the stopping than before it. During testing, both booster fans bulkheads were left open to avoid resisting airflow. An assumption was made that based the area of the airways on a rectangular shape. This made the areas easier to measure and calculates.

Table 4.1 Main fan quantity survey

Stopping		Q (m <sup>3</sup> /s)	$\Delta Q$ (m <sup>3</sup> /s)
1	b	17	
	a	16	1
2	b	16	
	a	18	-1
3	b	17	
	a	19	-2
4	b	18	
	a	18	0
5	b	18	
	a	16	2
6	b	16	
	a	15	1
7	b	15	
	a	17	-2
8	b	17	
	a	14	3

The location of these stoppings with negative  $\Delta Q$  makes it unlikely for that these negative values indicate recirculation. The increased quantity of airflow at stoppings 3, 5 is due to leakage from the other airway across the individual stopping. Since this leakage is from the intake into the return, it cannot be classed as recirculation. Stopping 2 indicates that there is recirculation across the stopping. This is inconsistent with the type of ventilation system used since there is no new source of pressure introduced in the return airway. From the intake shaft to the exit of the mine, the quantity of leakage does not seem to be affected by the distance from the main fan. As expected, the pressure differences across the stoppings increase as the distance from the main fan increases as indicated by Table 4.2. These pressure difference increases theoretically mean that the leakage increases as the distance increases away from the pressure source. The limiting factor of this theory is the ability of the individual stopping to minimize the leakage across it. The results in Table 4.1 show that at stopping 5 there is more leakage than at any other stopping not influenced by leakage coming from the other side of the stopping where measurements were taken. This correlates with the higher pressure difference at stopping 5 shown in Table 4.2.

Table 4.2 Pressures differentials across stoppings due to main fan

PRESSURE ACROSS		MAIN FAN ONLY (Pa)
Stopping 1		24.91
Stopping 3		139.61
Stopping 5		232.69
Stopping 8		336.67

**4.1.3.2. Scenario 2: Main fan and the east booster fan.** A combination of the Missouri University of Science and Technology Experimental Mine main fan and the east located booster fan was run at different blade angles to test for leakage. The mine main fan parameters were kept constant as those used in the first scenario discussed in Section 4.1.3.1 above. The booster fan was run at 1140 rpm at blade angles 5°, 10°, 15° and 20° which are represented simply as blade angle one, two, three and four. Blade angle 5 which represents blade angle 25° was run at 960 rpm. Although this created an inconsistency with the other blade angles, running the fan at this blade angle beyond 960 rpm overloaded the Missouri University of Science and Technology Experimental Mine electrical circuit and caused power overload failures on the variable frequency drive unit. The rpm was set from the variable frequency drive while the fan blade angles were manually changed on the booster fan. Blade angle set 6 which represents 30° was not run. During these tests, the west booster fan bulkhead was left open so as not to provide resistance to airflow.

The experimental results are presented in Table 4.3. The results show the amount of leakage at each stopping for every booster fan blade angle and mine main fan combination.

Table 4.3 Leakage due the main fan and east booster fan

		Blade set at 1		Blade set at 2		Blade set at 3		Blade set at 4		Blade set at 5	
STATION		Q (m3/s)	ΔQ (m3/s)	Q (m3/s)	ΔQ (m3/s)	Q (m3/s)	ΔQ (m3/s)	Q (m3/s)	ΔQ (m3/s)	Q (m3/s)	ΔQ (m3/s)
1	b	18	1	19	1	20	0	19	-2	21	-2
	a	17		18		20		21		23	
2	b	17	-3	18	-1	20	-2	21	-3	23	-3
	a	20		19		22		24		26	
3	b	21	2	22	2	23	2	25	2	27	4
	a	19		20		21		23		23	
4	b	19	1	20	1	22	2	23	2	23	2
	a	18		19		20		21		21	
5	b	18	0	19	1	18	-1	19	1	21	2
	a	18		18		19		18		19	
6	b	18	2	18	1	18	2	18	2	19	1
	a	16		17		16		16		18	
7	b	16	-1	17	-2	18	-1	20	-1	21	-2
	a	17		19		19		21		23	
8	b	17	2	19	3	20	3	21	4	24	5
	a	15		16		17		17		19	



The main fan and east booster fan combination results shown in Table 4.3 indicates that at blade angle 1, there are leakages at every stopping with stopping 5 having leakage that is less than  $1\text{m}^3/\text{s}$ . From the intake shaft to the mine exit, the leakages rates do not reflect any pattern but vary independently of the location with respect to that of the booster fan. Stopping 2 shows leakage from the return into the intake airway. This leakage occurs despite the fact that the stopping is located just prior to the introduction of the booster fan as indicated in Table 4.4. The introduction of the booster fan means there is less pressure before the booster fan than that after the booster fan. Also, the stopping is located at the intake where the pressure is highest but as seen in the discussion of Section 4.1.3.1 of scenario 1, the leakage seems to be flowing into the opposition direction as expected. This anomaly may be caused by the location of the stopping with regards to its close proximity to the Kennedy machine doors. The leakage in or out through the Kennedy machine doors was not determined. Measuring velocity of airflow in at the Kennedy machine doors entry airway was impossible as the airflow velocity was too low to be measured. Leakage from the intake stopping 5 increases the quantity of airflow in the return and therefore resulting in a negative air quantity difference after stopping 7.

As in the case of scenario 1 in 4.1.3.1, the pressure difference in this main fan and booster fan combination running at blade 1 increase from the intake to the exit. The pressure difference is highest at stopping 8 where leakage is highest. It can also be noted that due to the introduction of a new pressure source, leakage into station 3 has ceased. This then brings up the question of whether leakage at this station is into the intake or return airways. This cannot be proven mathematically and therefore requires a simulation to be carried out.

Table 4.4 Pressure differences across stoppings due to main and east booster fans

Pressure across stopping (Pa)	Main fan & East @ 1	Main fan & East @ 3	Main fan & East @ 4	Main fan & east @ 5
Stopping 1	4.98	24.91	24.18	24.91
Stopping 3	4.98	39.85	138.63	232.69
Stopping 5	64.76	32.38	166.68	139.61
Stopping 8	179.34	32.38	245.67	413.65

The same results observed for blade angle 1 can also be observed for blade angle 2. As shown in Table 4.3, the same stopping stations for blade 1 and blade 2 have positive and negative leakage quantities all the same. Stoppings 2 and stopping 7 have negative airflow quantity differences therefore the same leakage behavior conclusions can be logically drawn. The quantitative value of leakage throughout the entire ventilation system does not vary greatly from that observed for the main mine fan only or that the combination of the main mine fan and the east booster fan at blade angle 1. The increase in air quantity pushed throughout the mine due to the use of the booster fan at these two fan blades does not affect the behavior of leakage flow between the two of them.

A different observation for blade angle 3 can be made from Table 4.3. At stopping 1, the leakage is less than  $0.5\text{m}^3/\text{s}$ . This indicates the greater stopping integrity since the pressure difference across is higher than previous blade angle one test as shown in Table 4.4, therefore ruling out pressure difference as the main reason. Stopping 5 exhibits leakage from the return into the intake airway. This is different from all the test blade angles run for the main mine fan and east booster fan combination. Such a result was not expected as there was no other pressure source after this stopping. It is also noted that this stopping had the highest pressure difference across the stopping as shown in Table 4.4. This however does not help to explain why such leakage behavior is observed. Also, this observation is not helped by the observation at stopping 7 which should have a positive difference since the results suggest that air leaks through that side of the stopping into the intake. The pressure differences across the stopping in this setting is fairly consistent

which then points to the integrity of the stopping as the principal cause of different leakage rates at each stopping.

Booster fan blade angle settings 4 and 5 exhibit another different leakage behavior compared to that observed for the previous blade angles. As shown in Table 4.3, stopping 1 indicates that there is leakage from the adjacent airway into the intake airway. This is due to the high pressure created by the booster fan running at high speeds. These set of blade angles also indicate higher leakage rates across the entire ventilation system. It should also be noted that at stopping 3, there is a sufficient amount of leakage that cannot be regarded as leakage into the intake or return by looking at the survey table. From the map shown in Figure 4.4, it is noticeable that leakage flow has two possible paths at station 3. This therefore means that the airflow can be either into the return and out of the mine or into the intake and through the mine ventilation network once more. It is at these blade angles that the behavior of leakage most scrutinized. The leakage of airflow from the return into the intake is associated with several notable mine fire catastrophes, most notably the Sunshine Mine fire in Idaho (Jarrett et al. 1972).

Table 4.4 shows that blade angle settings 4 and 5 also results in the highest pressure differences across stoppings. This therefore has the potential of leading to high leakage rates across the stoppings. It is therefore fair to conclude that at the current booster fan location; lower blade angles 1, 2, and 3 do not adversely affect the behavior of airflow with regards to leakage as compared to higher blade angles 4, 5. The high blade angles not only show a different airflow pattern but also as increased quantity of air leakage. It should be noted that the effects of the Kennedy machine doors on leakage in or out of the mine through it was never taken into consideration at any point.

**4.1.3.3. Scenario 3: Main fan and the west booster fan.** This scenario involves the measurement of air leakage rates as discussed in the previous scenarios using the Missouri University of Science and Technology Mine main fan and the booster fan located at the western end of the mine. The map in Figure 4.4 shows that the west booster fan is located in the return airway as compared to the east booster fan which is located in the intake airway. The operating parameters for this scenario parallels those discussed in scenario one including not running the west booster fan at blade angle setting 6 for the same reasons as those of the east booster. The results from the test scenario are shown in Tables 4.5 and 4.6 which show air leakage through stoppings and the pressure differences across different stoppings respectively. The east booster fan bulkhead was left open during the entire experimentation of this scenario so as to avoid restricting the airflow.

Table 4.5 Leakage due the main fan and west booster fan

		Blade set at 1		Blade set at 2		Blade set at 3		Blade set at 4		Blade set at 5	
Stopping		Q (m3/s)	$\Delta Q$ (m3/s)	Q (m3/s)	$\Delta Q$ (m3/s)	Q (m3/s)	$\Delta Q$ (m3/s)	Q (m3/s)	$\Delta Q$ (m3/s)	Q (m3/s)	$\Delta Q$ (m3/s)
1	a	17		18		23		22		23	
	b	16	1	17	1	21	2	21	1	22	1
2	a	16		17		21		21		22	
	b	18	-2	19	-2	23	-2	23	-2	24	-2
3	a	17		20		21		20		25	
	b	16	1	18	2	23	-2	22	-2	26	-1
4	a	17		20		23		25		25	
	b	16	1	19	1	23	0	23	-3	27	-2
5	a	16		19		23		23		25	
	b	16	0	19	0	25	-2	25	-2	28	-3
6	a	17		19		25		24		26	
	b	16	1	17	2	23	2	22	2	24	2
7	a	23		23		25		25		27	
	b	21	2	22	1	22	3	22	3	24	3
8	a	21		23		22		22		24	
	b	18	3	19	4	18	4	19	3	20	4

Table 4.6 Pressure differences across stoppings due to main fan and west booster fan

Pressure across stopping (Pa)	Main fan & west @ 1	Main fan & west @ 3	Main fan & west @ 4	Main fan & west @ 5
Stopping 1	29.89	119.56	244.11	465.38
Stopping 3	34.87	124.54	74.46	188.97
Stopping 5	9.96	74.73	60.5	78.97
Stopping 8	13.38	35.98	45.11	63.33

The booster fan blade settings 1 and 2 for the main mine fan and west booster fan combination show similar results as indicated in the Table 4.5, the behavior of leakage for both is similar. They also exhibit the same observation made for all the blade angle tests in scenario 1 and scenario 2 of airflow leakage across stopping 2 into the intake. Stopping 7 for both blade settings shows leakage from the return into the intake but the difference in quantity of airflow is not reciprocated by the results at stopping 5 which is the opposite side of stopping 7. Stopping 5 for both blade settings show zero or near zero leakage which contradicts the results showing that air leaks from the other side of the stopping into that station. This stopping also exhibits less difference in pressure across it as shown in Table 4.6. This might help explain the leakage rate across stopping 5 but then fails to deal with leakage across stopping 7.

At booster fan blade setting 3, a different observation from that of blade settings 1 and 2 can be made. Apart from stopping 2, this setting exhibits leakage into the intake from the return at stoppings 3 and 5. It also shows increased leakage rates at stoppings 7 and 8. It is noticeable from Table 4.6 that the pressure differences have now reversed as compared to that in Table 4.4. The pressure differences are highest at the intake than in the return and this is caused by the introduction of the west booster. Unlike the observations made for booster fan blade settings 1 and 2 for this fan combination, the behavior of leakage adds up to the results from the experiment. At stopping 5, there is more airflow quantity measured after the stopping than before it and this correlates to the additional airflow quantity leaking through that same stopping but from the other side of it (stopping 7).



The results observed for blade settings 4 and 5 are the same as that of blade setting 3 with one exception at stopping 4. At this stopping, air leakage is introduced into the intake airway from the return. Quantity of leakage at stoppings 5 and 7 also adds up as leakage into the return measured at stopping 7 is also observed with the increase in quantity of airflow after stopping 5. The same observation made for all the fan combinations and blade angle settings is also apparent in for these blade angle settings at stopping 2. It should also be noted that the quantity of leakage at this stopping is the same for all the blade angle settings run for the mine main fan and west booster fan combination.

**4.1.3.4. Scenario 4: Main fan, east and west booster fan.** This scenario combines the mine main fan and the east and west booster fans operating in tandem. The booster fans were operated at similar blade angles at each test run and the speed rpm was also maintained between the two. Although the use of booster fans in series is highly discouraged by the Mine Safety and Health Administration (MSHA), this scenario was carried just for the purpose of research instead of modeling the true ventilation scenario in a proper underground mine. The same parameters from the previous scenarios were used in this scenario also, including the number of blade angles, booster fan rpm and the running speed of the main mine fan. During this test, all the bulkhead doors remained closed. This was meant to avoid recirculation at the bulkheads since all fans were operated simultaneously. The results from this test scenario are presented in Table 4.7.

Table 4.7 Leakage due the main fan, east and west booster fans

Stopping		Blade set at 1		Blade set at 2		Blade set at 3		Blade set at 4		Blade set at 5	
		Q (m3/s)	$\Delta Q$ (m3/s)	Q (m3/s)	$\Delta Q$ (m3/s)	Q (m3/s)	$\Delta Q$ (m3/s)	Q (m3/s)	$\Delta Q$ (m3/s)	Q (m3/s)	$\Delta Q$ (m3/s)
1	b	17	1	17	1	18	1	18	1	20	2
	a	16		16		17		17		18	
2	b	16	-2	16	-1	17	-3	17	-4	18	-4
	a	18		17		20		21		22	
3	b	19	1	19	2	25	5	25	2	29	3
	a	18		17		21		23		26	
4	b	17	1	22	4	27	3	28	4	32	5
	a	16		18		24		24		27	
5	b	16	1	18	1	24	2	24	-2	27	-1
	a	15		17		22		26		28	
6	b	16	2	17	2	24	3	25	3	28	2
	a	14		15		21		22		26	
7	b	17	1	23	3	25	-1	29	2	34	3
	a	16		20		26		27		31	
8	b	16	2	20	3	26	4	29	5	33	7
	a	14		17		22		24		26	

The combination of the main mine fan and both booster fans produces results that show the influence of both booster fans on the behavior of airflow. It can be noted from Table 4.7 that the blade angle settings 1 and 2 exhibits the same behavior as that shown by the use of the main mine fan and the west booster fan only. Although the value of quantity differs at each individual stopping, the behavior of airflow is identical. Stopping 2 shows the same behavior observed for all the previously discussed scenarios and all the blade angle settings tested. The blade angle setting 3 has results that parallel the main mine fan and the west booster fan combination but with rather higher values of quantity of leakage. Stoppings 4 and 5 show both results exhibited by the main mine fan-west booster fan combination and the main mine fan-east booster fan combination. The first half of the mine shows results that are reminiscent of the behavior of airflow due to the combination of the main mine fan and the east booster fan while the latter half shows the same behavior observed for the main mine fan and the west booster fan combination. This scenario produced the highest quantities of leakage from the blade angle setting 2 through 5, with the highest value being  $7\text{m}^3/\text{s}$ .

#### **4.2. RECIRCULATION**

Recirculation is a form of reusing air to ventilate an airway as the air passes the same district more than once. Jones (1986) defined recirculation as the movement of mine ventilation air past the same point more than once. Recirculation occurs when air leaks from the return airways into the intake airways as a result of high pressures in the return airways than that in the intake airways. Recirculation in a ventilation circuit occurs in two forms: controlled and uncontrolled recirculation. Controlled recirculation is a term

that is used to describe a recirculation circuit that is purposefully designed and utilized in a controlled fashion to provide some ventilation benefits without adversely affecting other ventilation variables (Hartman et al., 1997), fans are placed in a mine ventilation circuit to produce a desired recirculation quantity. In controlled recirculation systems, a portion of the return air is purposefully directed into the intake air and transmitted to the production areas and the quantity of recirculated air is closely monitored and managed (Calizaya, 2009).

The use of controlled recirculation circuits is considered to be beneficial in mines where; (Hartman et al., 1997)

- Mine intake air must be heated because of cold climates.
- Mine air is refrigerated for reasons of comfort or productivity.
- Added velocity at the face would result in better turbulent mixing of air and methane at the point of release.
- Added velocity at the face would more effectively carry away dusts.
- Working faces are far removed from the mine portals, such as in undersea mining.

Uncontrolled recirculation is an unplanned and unexpected air leakage from the return airways into the intake airways. This type of recirculation is not managed and therefore has been a deterrent in the use of booster fans in United States underground coal mines. The recirculation of mine air has in the past been avoided principally because of the fear of a buildup of pollutants, particularly methane concentration in the general body of the air.

Controlled recirculation has been a known form of ventilation for some time. Probably the use of deliberate recirculation dates back to British collieries, dating back to the early 1930s where it was used to improve comfort level in workings (Lawton, 1933). Although fundamental principles were established over thirty years ago (Bakke, Leach, and Slack, 1964; Leach, 1969) and the first large-scale controlled recirculation system was applied in a coal mine around that time (Robinson, 1972), extensive research and field applications did not get started until the late 1970s and early 1980s.

During the 1970's controlled recirculation systems were used in British coal mines (under Mines Inspectorate exemption) for dust control and methane scouring in advanced headings of longwall panels. In 1982 there were 1560 auxiliary ventilation systems being used in British coal mines of which 63 were arranged for controlled recirculation (Pickering and Robinson, 1984). In many UK coal mines air is transported over great distances, in some cases over 10 km. These distances sometimes results in insufficient air being available at the faces to achieve the desired velocities, although this air is often returned in a relatively uncontaminated condition (Pearce, 1984). The first district recirculation system in a British coal mine was commissioned at Wearmouth Colliery in 1986 (Robinson and Harrison, 1987). The major findings from this study were that ventilation contaminants remained at normal and acceptable levels, additional ventilation air was provided to the workings and considerable operating cost savings were made.

In South Africa, many deep mines are experiencing major environmental problems primarily due to the climatic conditions experienced when working at depths where the virgin rock temperature (VRT) exceeds 50°C. Underground trials of controlled district recirculation have been in progress since 1982 at Loraine gold mine in South

Africa (Burton et al., 1984). The main ventilation contaminant for the district chosen for the trials was heat and the initial conclusions from the study showed that recirculation enabled more efficient use of installed refrigeration capacity as well as providing increased airflow within the workings.

In Canada, due to the extremely low surface temperatures experienced, many mines pre-heat recirculated ventilating air. Research has been conducted in Canada (Hall, 1985) into the use of controlled recirculation on a whole mine basis in order to reduce the winter air pre-heating costs of underground mines.

In Australia a number of mines with a working depth in excess of 1,000 m have reached the point where satisfactory working can be achieved only with some form of cooling beyond that provided by normal ventilation. This is because many Australian mines are in isolated subtropical areas with high ambient summer wet- and dry-bulb temperatures on the surface. Generally acceptable practice in this situation largely has been to use refrigeration and chilled water to bulk cool areas accessible to men. Controlled partial recirculation of ventilation air produces an alternative to these costly measures. Instead of including the flow rate of fresh intake air, recirculated air enables air flow rates to be increased locally, the rate of temperature increase to be substantially decreased and bulk air coolers to be used for cooling entire areas (Wu et al., 1995).

**4.2.1. Measuring Recirculation at Missouri S&T Experimental Mine.** The airflow quantity measurements taken in Missouri S&T Experimental Mine to investigate recirculation were taken simultaneously with those used to investigate leakage (Section 4.1.3.). This included the same measuring procedure and technique. All the fan

combinations were also investigated at the same blade angle settings and similar stoppings as before.

**4.2.2. Calculating Recirculation.** The method of averaging airflow quantity before and after each stopping discussed in Section 4.1.2.3 was used. Equation 4.9 ( $Q_b - Q_a = \Delta Q$ ) was also used during these investigations as it was when investigating leakage. Ideally, the negative  $\Delta Q$  represents recirculation but as the investigation continues, it will become evident that not all negative  $\Delta Q$  measurements mean recirculation. This is because of the design of the mine and the ventilation path which the ventilating air follows (Figure 4.4).

**4.2.3. Scenario 1: Main Fan Only.** Since the results from this test scenario are the same as those in scenario 4.1.3.1, Table 4.1 will be used during the analysis of this scenario. The results shown indicate negative  $\Delta Q$  at stoppings 2, 3 and 7. For stoppings 3 and 7, these negative values indicate leakage from the intake airway side of the stopping into the return airway side of the stopping. This leakage does not pass the same point twice and therefore cannot be classed as leakage. Table 4.2 shows the pressure differentials across stopping 3 and stopping 7 which indicate the kind of situation which would allow such leakage. At stopping 2, the airflow leaks into the intake airway and passes the same point twice and therefore qualifies as recirculation. Theoretically, this should not be the case because there is no source providing a surge of pressure. The best hypothesis is that the location of the stopping which is opposite the Kennedy machine doors gives rise to this phenomenon. This creates more pressure on the opposite side of stopping 2 thus leading to recirculation.

**4.2.4. Scenario 2: Main Fan and the East Booster Fan.** Table 4.3 represents the results from the main fan and east booster fan combination test runs. From the results, the observation made for stopping 2 in Section 4.1.3.2 prevails for all the blade angle settings. This therefore leads to the conclusion that the east booster fan does not have an effect on the behavior of recirculation at this stopping. The average value of recirculation does change relative to the blade angle used but the direction of leakage through the stopping remains the same. Blade angle settings 1 and 2 show negative  $\Delta Q$  at stopping 7, but this has already been classified as leakage from the intake airway into the return airway. The recirculation observed at stopping 5 is likely to be due to experimental errors rather than being the result of using the east booster fan. The location of stopping 5 and the eastern booster fan means that the pressure created by the east booster fan is before the stopping rather than after it. Table 4.4 shows a pressure differential of 32 Pa across stopping 5 which indicates leakage across the stopping into the return and not as the results show.

Recirculation can be observed at stopping 1 for blade settings 4 and 5. This shows that the east booster fan creates higher pressure values in that airway rather than in the airway opposite it. Although the pressure differentials for blade angles 3, 4 and 5 are the same, the leakage caused by blade angle setting 3 is very small. Unlike stopping 2, stopping 1 is located after the booster fan which means that the recirculation recorded is true and can be reasonably explained. It is important to note that although stopping 3 indicates positive  $\Delta Q$ , there is a probability that airflow leaks into the intake and this only shows as leakage than recirculation. This recirculation or the lack of it cannot be



measured due to the positioning of the stopping near the intake shaft through which recirculation would be possible.

**4.2.5. Scenario 3: Main Fan and the West Booster Fan.** From Table 4.5, blade angle settings 1 and 2 do not show any recirculation except at stopping 2 which has already been discussed. Blade setting 3 introduces recirculation points at stoppings 3 and 5, with potential for recirculation at stopping 4. One more circulation station is observed at stopping 4 for blade settings 4 and 5. The amount of recirculation at each stopping does not seem to be dependent on the blade angle. The pressure differentials in Table 4.6 show that although they facilitate recirculation, they also do not influence the quantity leaking through the stoppings. This is indicated by higher pressure differentials for blade setting 4 but lower recirculation rates.

**4.2.6. Scenario 4: Main Fan, East and West Booster Fans.** This scenario combines the mine main fan, the east booster fan and the west booster fan and investigates the potential for recirculation. Using both booster fans simultaneously creates a high pressure source in the first half of the mine and the latter part of the mine. This reduces the potential for recirculation as the pressures from both fans cancel out. From Table 4.7, less recirculation is observed than that in Section 4.2.4. The recirculation measured is evident in booster fan blade settings 4 and 5 at stopping 7 due to the use of the west booster fan. There is a possibility that the east booster fan creates recirculation at stopping 3 which cannot be proven by this method of investigating recirculation. However this can be proven by the use of Ventsim modeling.

### 4.3. CONCLUSION TO SECTION

From the investigations of behavior in recirculation and leakage under the influence of booster fans, these conclusions can be drawn;

- The amount of leakage created does not depend on the booster fan used but rather on the integrity of the stopping. This is shown by stoppings that have higher leakage rates at lower blade angle settings and lower pressure differentials than those with higher values. The highest leakage rates are observed when both booster fans are in use and at blade angle settings 4 and 5.
- Using the booster fan creates higher pressure at the part of the mine where the booster fan is located. This in turn creates higher leakage rates at the stoppings furthest from the booster fan. The west booster fan creates the highest leakage rate at the eastern part of the mine while the east booster fan creates the highest leakage rates at the western part of the mine. When using both booster fans, the higher leakage rates are spread unevenly throughout the stoppings in the mine.
- Recirculation observed at stopping 2 is not a result of the influence of the use of booster fans. This is because all fan combinations and the mine main fan only both experience such recirculation.
- Recirculation occurs when blade angle settings 4 and 5 are used for all the fan combinations which mean that they are oversized for the mine. The ideal blade setting would be blade angle setting 3 since it is not oversized or undersized for the mine.

- Recirculation is most pronounced at the stoppings that are closest to the booster fan that is being used. The recirculation that is caused by the east booster fan is concentrated at stopping 1 while that caused by the west booster fan is concentrated at stoppings 4 and 5.

## 5. VENTSIM VISUAL SIMULATION ANALYSIS

Ventsim Visual modeling software was used to simulate the current Missouri S&T Experimental Mine ventilation system to investigate the behavior of leakage and recirculation under the influence of booster fans. This was used as an additional tool to enhance the experimental investigation carried out at the Experimental Mine as the experiment did not definitely show all the possible recirculation paths in the mine. The same scenarios investigated in Section 4 were also investigated in this section.

### 5.1. VENTSIM VISUAL

Ventsim Visual is an underground mine ventilation simulation package designed by the company Chasm to simulate airflows from a network of airways. The Ventsim program was originally introduced in mining operations in 1993 while Ventsim Visual was released in 2009. The software integrates Windows graphical design with 3D graphics similar to high end computer-aided design (CAD) packages. Ventsim has been written to make the process of ventilation network analysis as easy to use as possible. Ventsim Visual incorporates both the incompressible flow and compressible flow concepts of fluid flow. It is also important to remember that this software only gives approximate answers to sometimes very complicated mine ventilation networks. The program uses a fully graphical mouse driven interface in Windows and has the following features (Ventsim Visual, 2012);

- Up to 20,000 individual airways can be entered into a network
- Up to 1000 different levels of airways can be used.

- Up to 1000 different types of fans, complete with efficiencies can be modeled within the network.
- 3D rotation allows the modeled network to be rotated in real time to assist in viewing and creating.
- Importing and Exporting ASCII or DXF data from spreadsheets or other CAD or Mine Planning packages.
- Pressure modeling of fans and fixed airflows.
- Load modeling on regulators and bulkheads
- Networks can easily be created true to scale in three dimensions, simply by drawing airways with the click of the mouse.
- Contaminant simulation allows simulations of smoke, fumes or other contaminants throughout a mine.

These features provide the user with the tools to;

- Simulate and provide a record of flows in an existing mine.
- Perform 'what if' simulations for planned new development.
- Help in short term and long term planning of ventilation requirements.
- Assist in selection of types and sizes of fans for mine ventilation.
- Help in choosing development fans and vent bag sizes.
- Assist in financial analysis of ventilation options.
- Simulate paths and concentrations of smoke, dust, or gas for planning or emergency situations.

Ventsim also has automatic heading directions which are based on how air would naturally flow when fans are setup. The airflow simulation can be setup in a number of

ways; by adding fans (each with individual fan curves), setting a fixed flow in a heading or setting a fixed pressure in a heading. By using “fan selection” a realistic circuit can be created with the amount of airflow that would actually be created by that fan with the given mine resistance.

## **5.2. MISSOURI S&T EXPERIMENTAL MINE VENTILATION SYSTEM**

A pressure quantity survey was carried and the results have been used to calibrate the Ventsim model. The survey aimed to acquire data that quantifies the distributions of airflow, pressure and air quality throughout the main airways. The (k) Atkinson friction factor for each branch has been calculated and inputted into the model. At each measuring station, as shown in Figure 5.1, absolute static pressure, air velocity, airway dimensions and air temperature (wet bulb/dry bulb) readings were taken.

Based on survey raw data, air quantity and static pressure losses between each measuring stations were calculated. As absolute static pressures were measured, calibration for differences in elevation and air density between measuring points was necessary to obtain the static pressure loss. The airway resistance,  $R$ , was then calculated knowing both the air quantity and the pressure loss. From that, friction factor,  $K$ , was obtained by knowing the airway length, perimeter and cross sectional area. The results are presented in Table 5.1. These were then inputted into Ventsim Visual for calibration of Missouri S&T Experimental Mine.

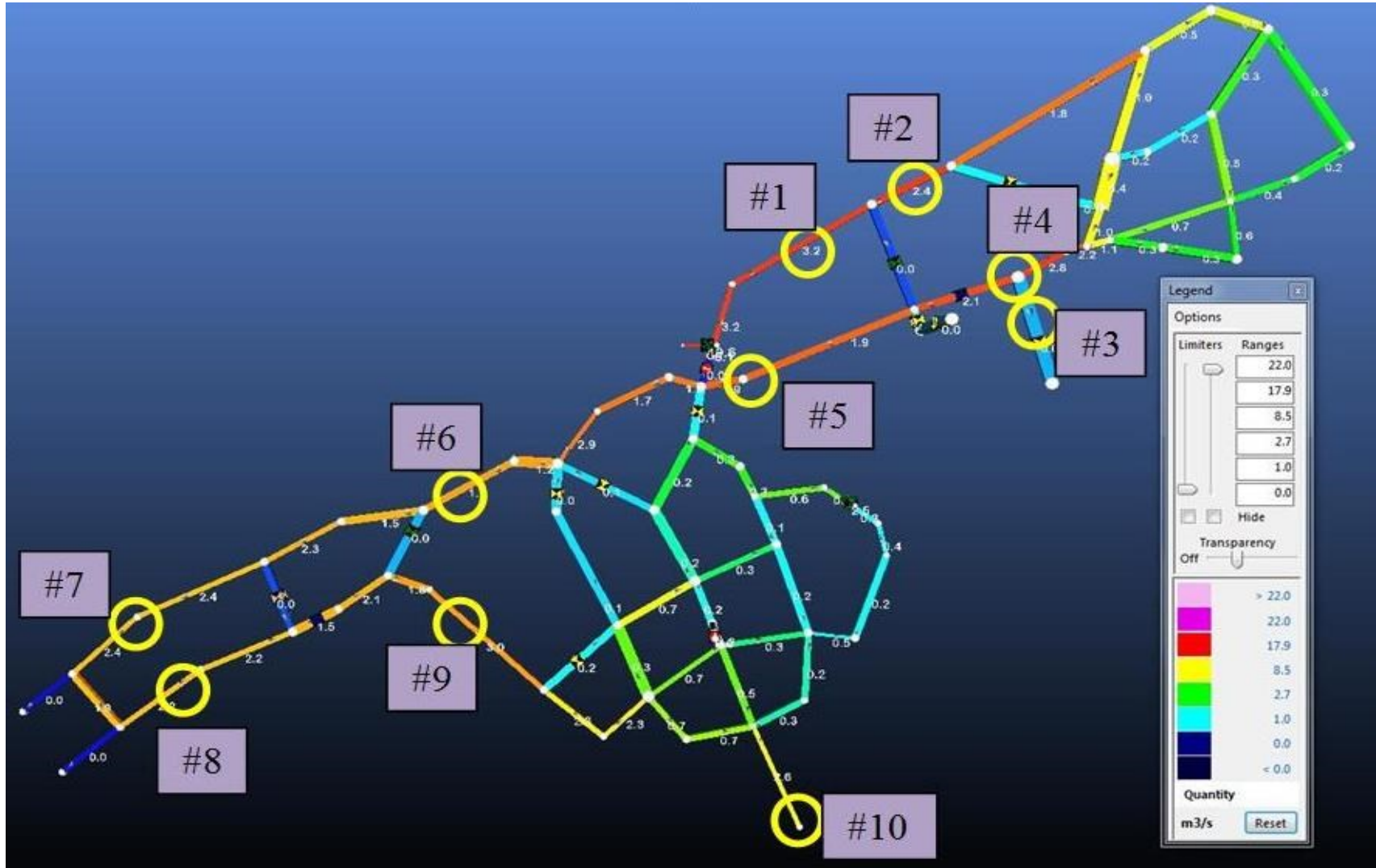

Figure 5.1 Pressure survey stations

Table 5.1 Pressure quantity survey results

Pressure Quantity Results																	
#	RL m	X-area		P m	Area m <sup>2</sup>	L m	RL Adj Pa	Ps kPa	ΔP		Ps adj Pa	Temp		V m/s	ρ kg/m <sup>3</sup>	R Ns <sup>2</sup> /m <sup>8</sup>	K Ns <sup>2</sup> /m <sup>4</sup>
		H	W						kPa	Pa		wb	db				
1	301.5	2.1	2.8	9.7	5.8	10.5	5.86	98.64	0.01	10	15.86	10.0	15.0	3.3	1.195	0.04567	0.0786
2	302.0	2.1	2.5	9.3	5.3	23	4.71	98.63	0	5	9.71	9.4	14.2	3.4	1.202	0.11461	0.3027
3	302.4	2.4	5.3	15.5	12.8	5.27	-7.10	98.63	0	5	2.10	10.8	11.9	0.02	1.206	0.02456	0.4259
4	301.8	2.6	3.4	11.9	8.7	20.1	-14.19	98.62	0.03	30	15.81	10.3	11.9	2.1	1.205	0.05196	0.1014
5	300.6	2.4	2.6	10.1	6.4	29	12.94	98.59	0.01	10	22.94	10.0	12.2	2.6	1.199	0.08521	0.0810
6	301.7	2.4	2.8	10.4	6.7	34	4.68	98.58	0	5	9.68	10.6	15.0	2.4	1.193	0.04415	0.0234
7	302.1	2.1	2.1	8.3	4.3	22.5	1.17	98.58	0.01	5	6.17	10.8	15.0	3.1	1.193	0.03745	0.0150
8	302.2	2.2	1.8	8.1	4.1	38	-14.09	98.57	0.11	110	95.91	11.1	15.0	3	1.197	0.50255	0.2069
9	301.0	2.1	3.0	10.3	6.4	37	-41.26	98.46	0.01	10	31.26	11.7	12.8	2.4	1.202	0.16824	0.0696
10	297.5	2.1	1.9	8.0	4.0			98.45		0		11.7	12.2	3	1.203	0.00000	



The cross-sectional areas of all the airways throughout the mine were measured, even those not along the ventilation path, and used to create a representative Ventsim model of the mine. A resistance of 50 Ns<sup>2</sup>/m<sup>8</sup> was used regardless of the condition of the stopping for all the stoppings in the mine, i.e. new or used. This was done to aid in quantifying the amount of leakage through every individual Kennedy stopping. Figure 5.2 represents an example of the parameters of an airway used for modeling the mine ventilation system.

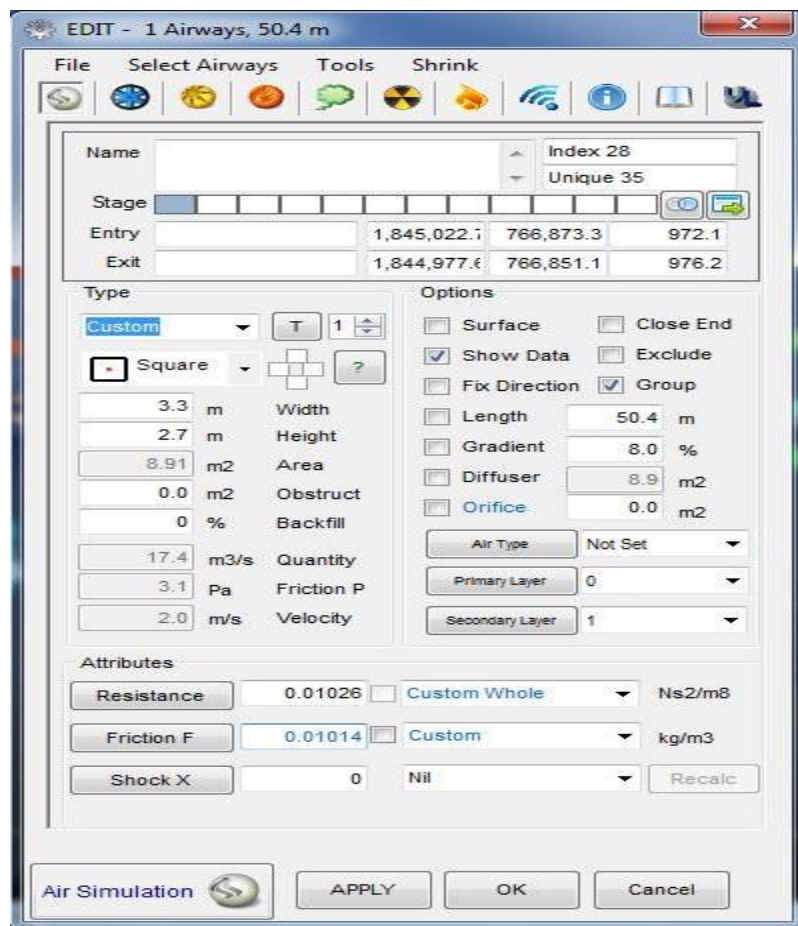

Figure 5.2 Mine airway parameters

**5.2.1. Scenario 1: Main Fan Only.** This scenario directly mirrors that investigated in Section 4 and investigates the behavior of airflow created by the mine main fan only. Figure 5.3 shows the mine main fan parameters produced by the Ventsim Visual simulation of the mine. During the simulation, the same mine main fan parameters as those used in Section 4 were kept constant and the mine ventilation profile also kept constant. The results from Ventsim Visual simulation for this scenario are presented in Figure 5.4.

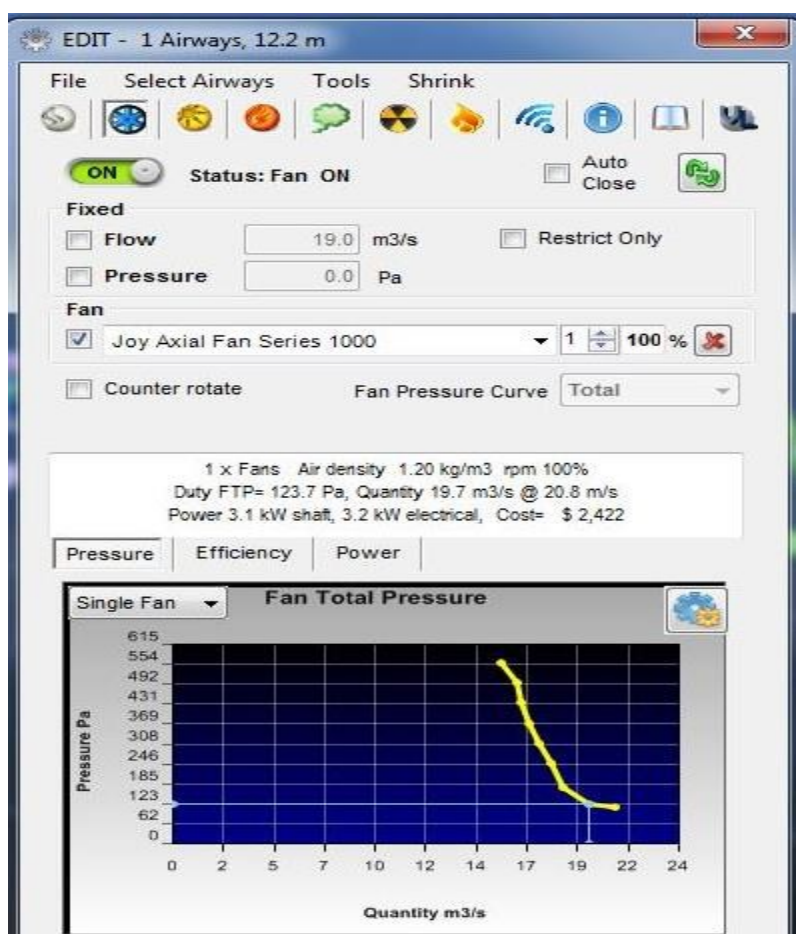

Figure 5.3 Main mine fan profile

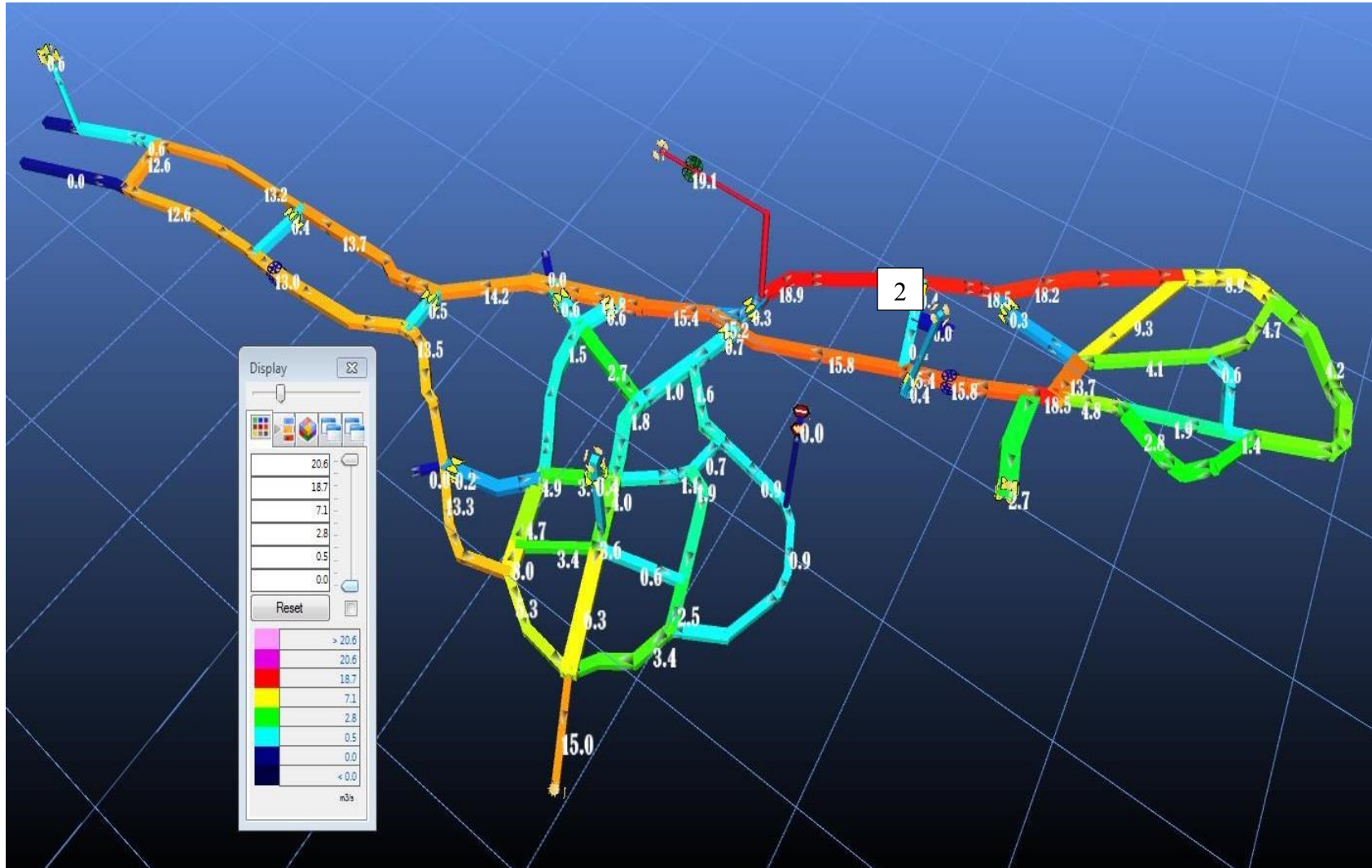

Figure 5.4 Mine main fan only simulation results



It can also be observed that there is no recirculation caused by the use of the mine main fan alone throughout the mine as theoretically expected.

**5.2.2. Scenario 2: Main Fan and the East Booster Fan.** The simulation of the combination between the main fan and the east booster fan requires individual simulation for each booster fan blade angle as simulating both blade angles is not possible. The lowest blade angle, the median blade angle and the highest blade angle were simulated. Since booster fan blade angles 1 and 2 showed similar results while blade angles 4 and 5 also showed the same behavior of airflow, blade angles 1, 3 and 5 were selected for simulation. Figure 5.6 shows the parameters of the east booster fan simulation.

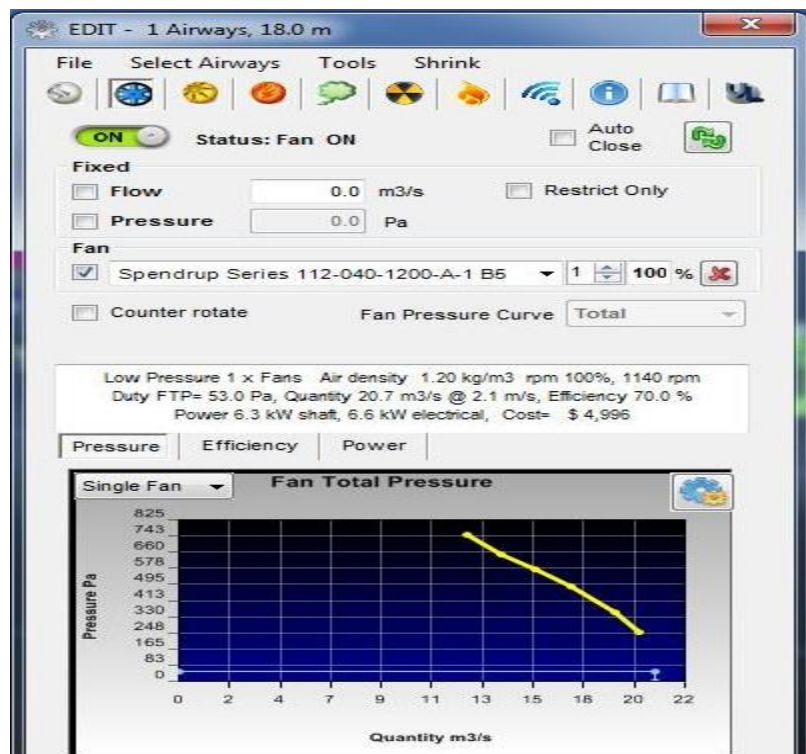

Figure 5.6 East booster fan profile

**5.2.2.1. Main fan and the east booster fan at blade setting 1.** With all previous east booster fan parameters maintained from the previous section, a simulation was run with the booster fan blade angle set at 1. The behavior of airflow caused by this fan combination at blade angle setting 1 is similar to that produced by using the mine main fan only. Figure 5.7 shows this behavior which only shows leakage and no recirculation. The leakage through stopping 3 from the main ventilation shaft side stopping is also evident as it was when using the main fan only. The results differ from those of the same scenario and blade angle setting in Section 4 as they do not indicate the same anomaly of observed recirculation at stopping 2.



**5.2.2.2. Main fan and the east booster fan at blade setting 3.** This combination at blade setting 3 produced different results as compared to those produced by blade angle settings 1 and 2 for the same settings under Section 4. The difference is also observed for the simulated results. This difference is observed at stopping 1 which experiences recirculation. Stopping 1 is in the first cross cut after the booster fan which is subjected to sudden pressure increase therefore leading to recirculation. The other stoppings exhibit the same leakage results as those observed in Section 4 and Section 5 (5.1.1 Scenario 1: Main fan only). Figure 5.8 indicates recirculation observed at stopping 1 due to the use of the east booster fan.

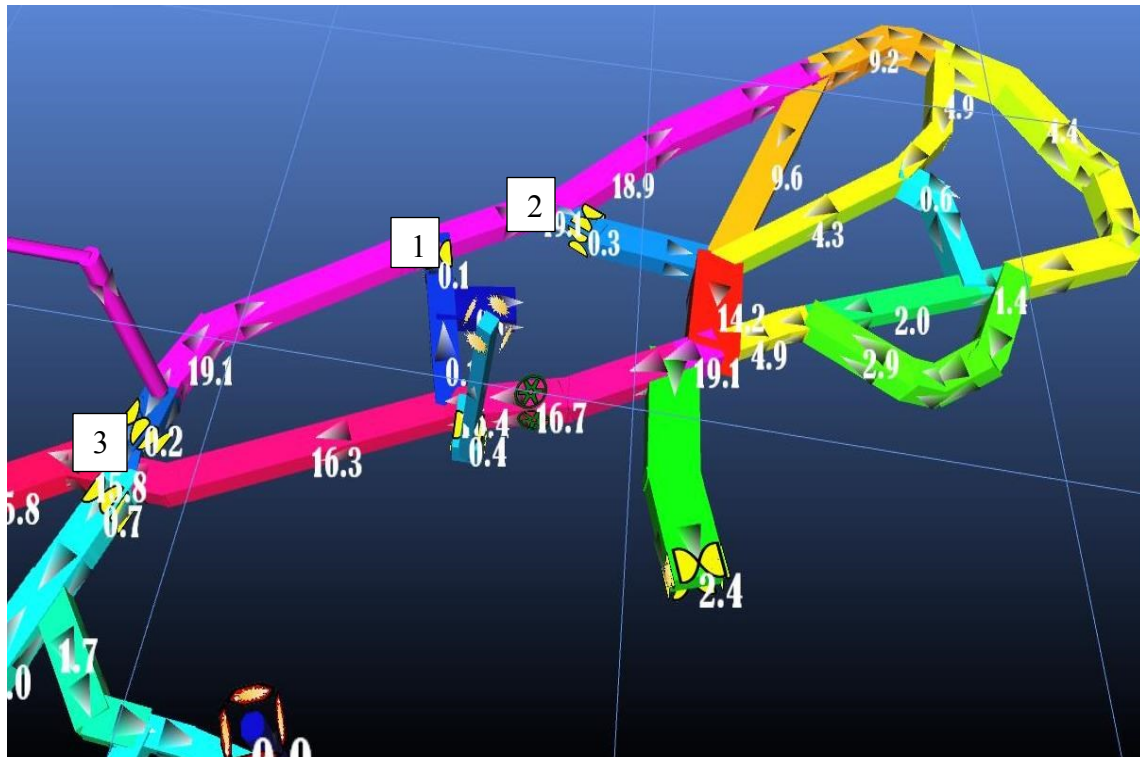

Figure 5.8 Main fan and east booster fan at blade set 3 simulation results



The recirculation indicated at stopping 1 is of very minimal airflow quantity ( $0.1\text{m}^3/\text{s}$ ) which indicates the possibility of recirculation during experimental analysis (4.1.3.2 Scenario 2). The absence of measurable leakage or recirculation ( $0\text{m}^3/\text{s}$ ) during experimental analysis in Section 4 is the indication that also led to such conclusions.

**5.2.2.3. Main fan and the east booster fan at blade setting 5.** This booster fan blade setting produced a substantial amount of leakage and recirculation during the experimental analysis in Section 4.1.3.2 Scenario 2: Main Fan and the East Booster Fan. In this scenario, the operating parameters were also kept constant with the ones in experimental analysis except for the rpm at blade setting 5 which was also run at 1140 rpm. The leakage through the stoppings for this simulation was identical to that of when using the booster fan only except for stoppings 1 and 3. These stoppings experienced recirculation higher than that experienced at blade angle setting 3. Compared to the experimental analysis, the simulated results show recirculation at stopping 3 which could not be investigated with definite conclusions. It is evident that air leaks through the stopping adjacent to the main ventilation shaft and therefore resulting in recirculation. This is shown in Figure 5.9.

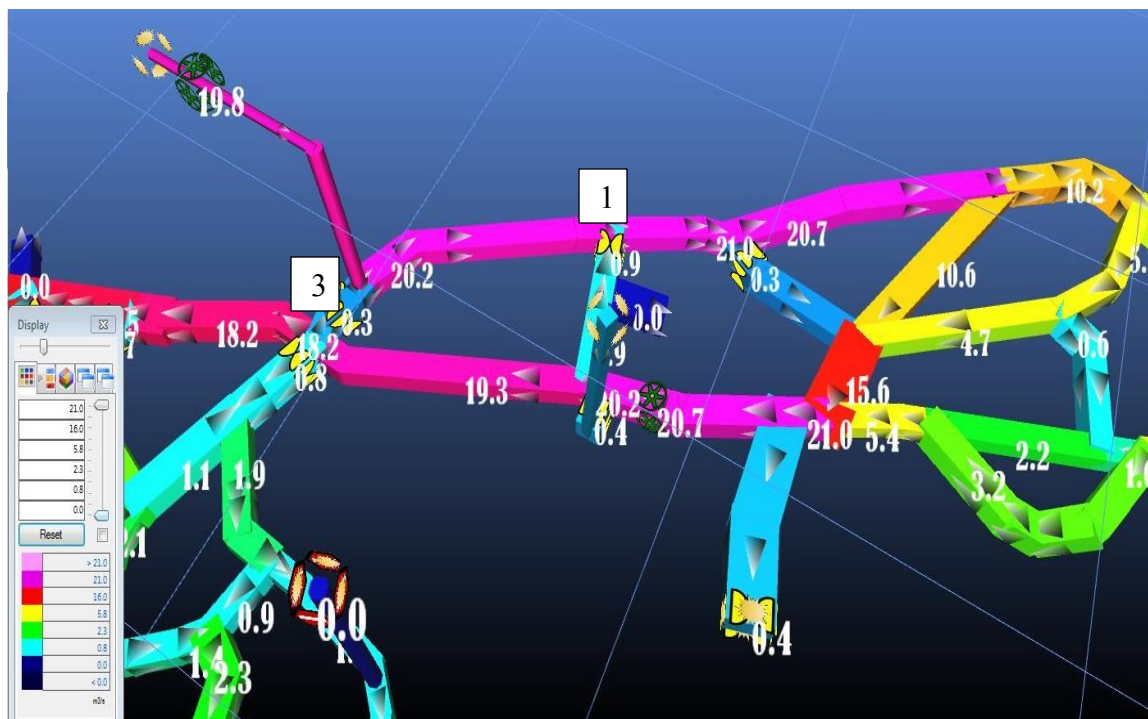

Figure 5.9 Main fan and east booster fan at blade set 5 simulation results

An observation was made that the recirculation was concentrated in the eastern part of the mine where the booster fan is located. The leakage from the simulation results is similar to that observed when using the mine main fan only. It varies differently across the mine but the rates do not have any relationship in regards to the east booster fan location. Since the same resistance was used for all the Kennedy stopping, the leakage rates are solely due to the use of booster fans than their condition.

**5.2.3. Scenario 3 Main Fan and West Booster Fan.** This scenario combined the mine main fan and the west booster fan at various blade angle settings as that in Section 5.1.2 to investigate recirculation due to the use of the west located booster fan. The operating parameters were also matched to those used in the simulation carried out in Section 5.1.2. These are shown in Figure 5.10 below.

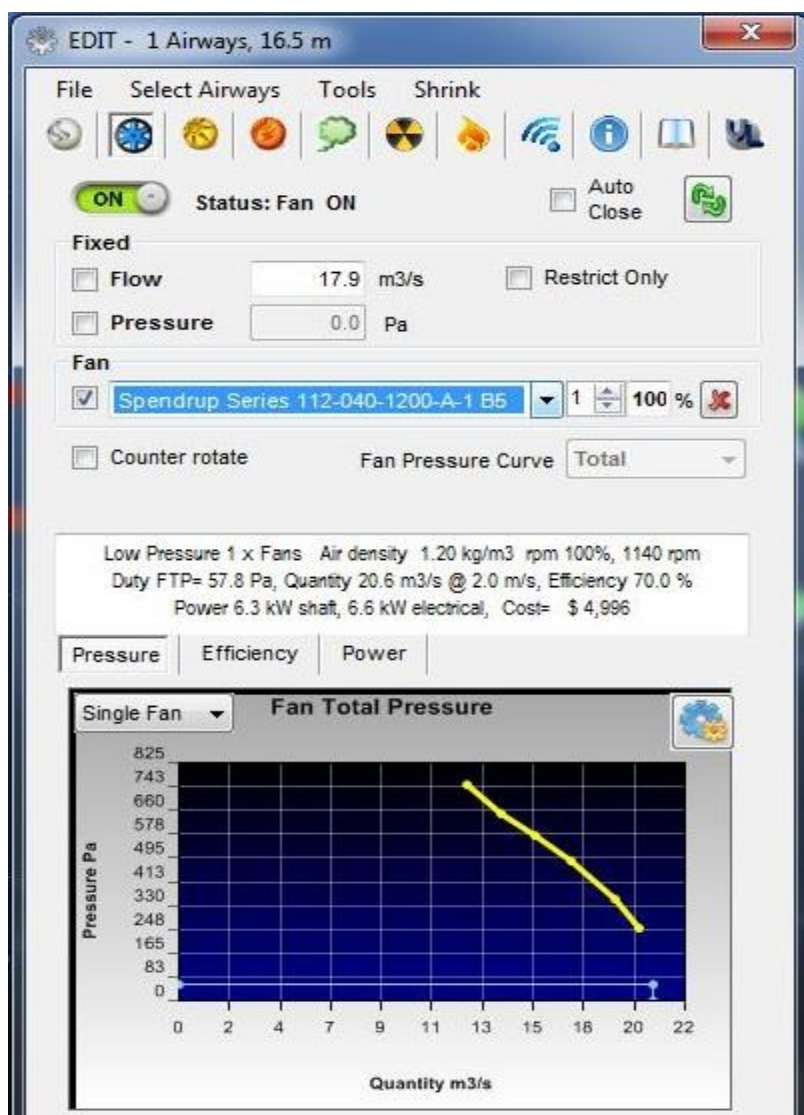

Figure 5.10 West booster fan profile

Blade angle settings 1, 3, and 5 were simulated for this scenario investigation and for the same reasons as those in Section 5.1.2

**5.2.3.1. Main fan and the west booster fan at blade setting 1.** The simulation results for the combination of the mine main fan and the west booster fan at blade angle setting 1 mirrors that when the mine main fan is the only ventilating fan. It is evident

from the simulated results in Figure 5.11 that the west booster fan at this blade setting does not alter the behavior of mine ventilating air. The leakage observed for the use of the mine main fan occurs at the same points as those observed for this fan combination and blade angle setting. Recirculation is not observed at this booster fan blade angle. It is also important to note that the anomaly of recirculation observed at stopping 2 during the experimental analysis in Section 4 is not observed in these simulated results.

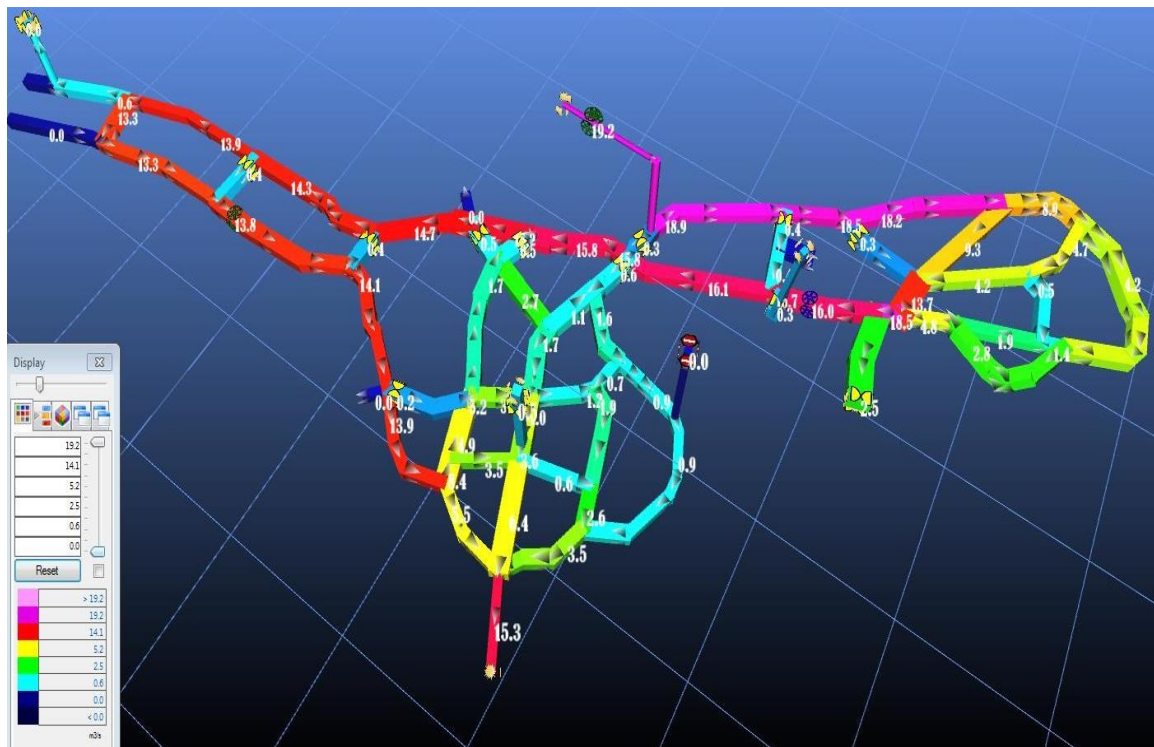

Figure 5.11 Main fan and west booster fan at blade set 1 simulated results

**5.2.3.2. Main fan and the west booster fan at blade setting 3.** The observations made for the combination of the mine main fan and the west booster fan at blade angle setting 3 shows a distinct difference from the observations made for the use of the mine main fan only. Recirculation can be observed at stopping 5 which is the first cross cut

after the location of the booster fan as shown in Figure 5.12. From the experimental analysis in Table 4.5, two more recirculation stations are observed and these are at stoppings 2 and 3. However, this observation is not apparent in the simulated results. This difference may be a result of the difference in the resistance of the actual stoppings in the underground mine and the resistance assigned to Kennedy stoppings for Ventsim Visual simulation. The assigned resistance for the Kennedy stoppings in simulations is for leaky stoppings and therefore may be higher or lower than the actual resistance of the stoppings in the experimental analysis.

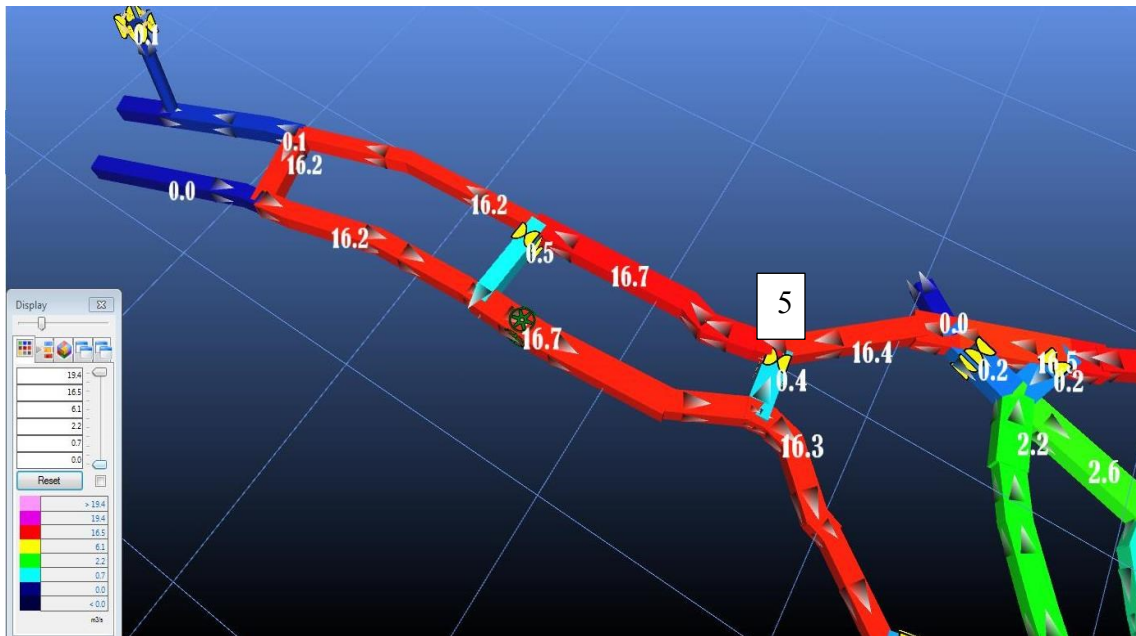

Figure 5.12 Main fan and west booster fan at blade set 3 simulated results

**5.2.3.3. Main fan and the west booster fan at blade setting 5.** This combination of the main fan and the west booster fan at blade setting 5 produced the most observed

recirculation points during simulation. Recirculation can be observed at stoppings 3, 4 and 5 in Figure 5.13. These recirculation points are located on the western bloc of the mine while leakage that is similar to that produced when using the mine main fan only are present in the eastern part of the mine. The observation made during the simulation of this fan combination at blade angle setting 5 are similar to those observed during experimental analysis as shown in Table 4.5. Both observations show recirculation in the stoppings in the vicinity of the western booster fan and leakage in the eastern part of the mine. For both the experimental analysis and the simulated results, this blade angle setting has the most effect on the behavior of leakage and recirculation due to the use of booster fans.

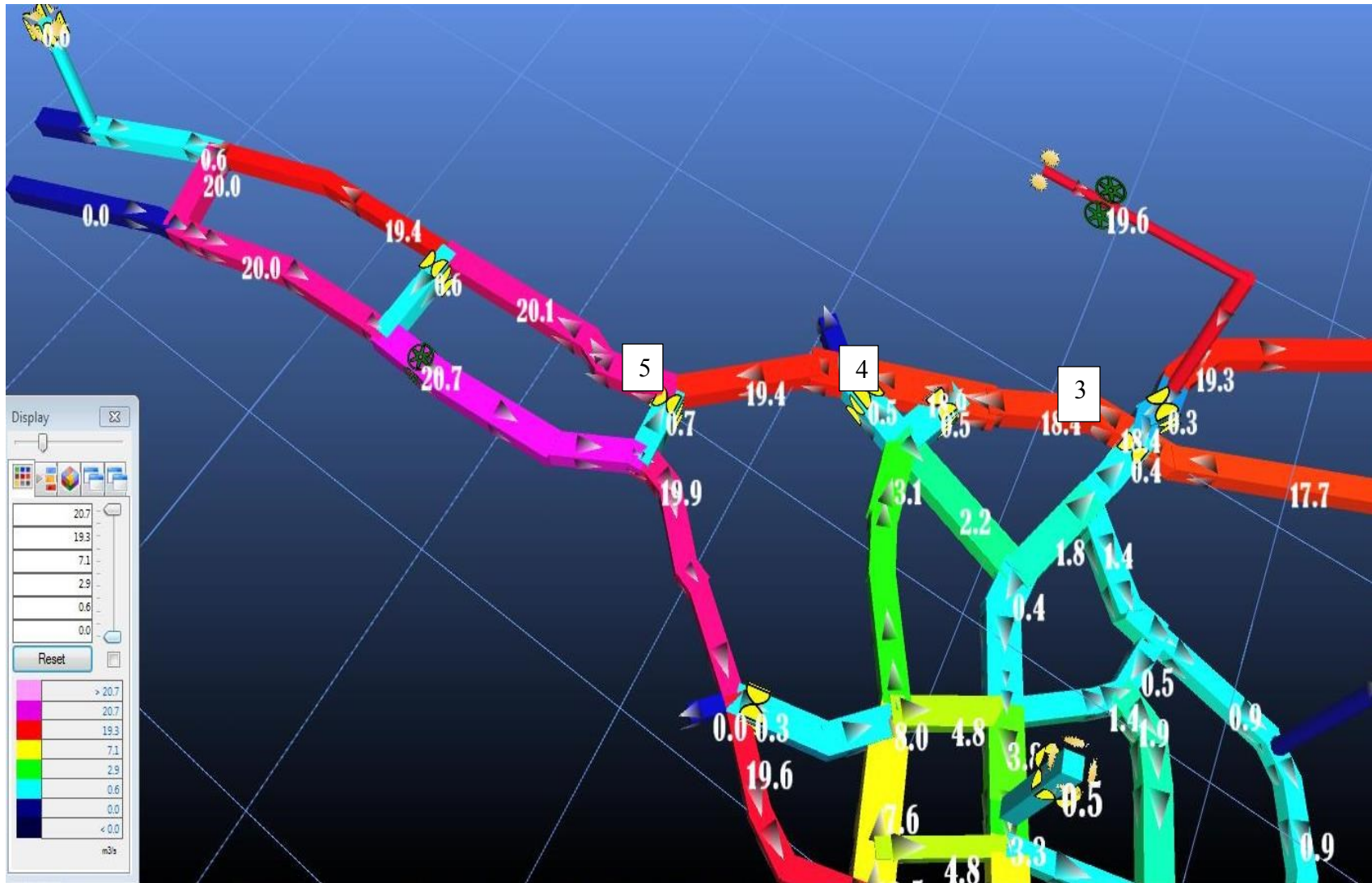

Figure 5.13 Main fan and west booster fan at blade set 5 simulated results

**5.2.4. Scenario 4: Main Fan, West Booster and East Booster Fan.** This scenario combines the use of the mine main fan together with both the east and west booster fans. The booster fan operating parameters were matched at every simulation which means they had to be operating at the same blade angle setting and rpm. Booster fan blade angle that were simulated included blade settings 1, 3 and 5.

**5.2.4.1. Main fan, west booster and east booster fan at blade setting 1.** The series combination of the mine main fan and both booster fans was simulated at blade angle setting 1 and the model is represented by Figure 5.14. It shows that this fan combination does not change the behavior of leakage and recirculation when compared to the behavior observed when using the mine main fan only in Section 5.1.1 Scenario 1. For this type of combination, no recirculation is observed as compared to that observed during experimental analysis as shown in Table 4.7. Since the behavior of leakage and recirculation is not altered by this combination then it is fair to conclude that this combination has no effect on the behavior of recirculation and leakage.





**5.2.4.2. Main fan, west booster and east booster fan at blade setting 3.** From Figure 5.15, it is evident that the combination of the mine main fan and both booster fans at blade angle setting 3 parallels the observation made when using the mine main fan only except for one stopping. Recirculation can be observed at stopping 5 under this setting which is closer to the west located booster fan. This observation also coincides with that made during experimental analysis except at stopping 2 which has been ruled as an anomaly. Since the eastern booster fan is located in an airway adjacent to the intake airway, the pressure introduced by the booster fan is not high enough to exceed that produced by the main fan. This therefore gives rise to low leakage values and lack of recirculation. The western booster fan introduces recirculation as pressure differential across the stopping is less as compared to the eastern booster fan. This fan setting does not greatly affect the behavior of leakage and recirculation.

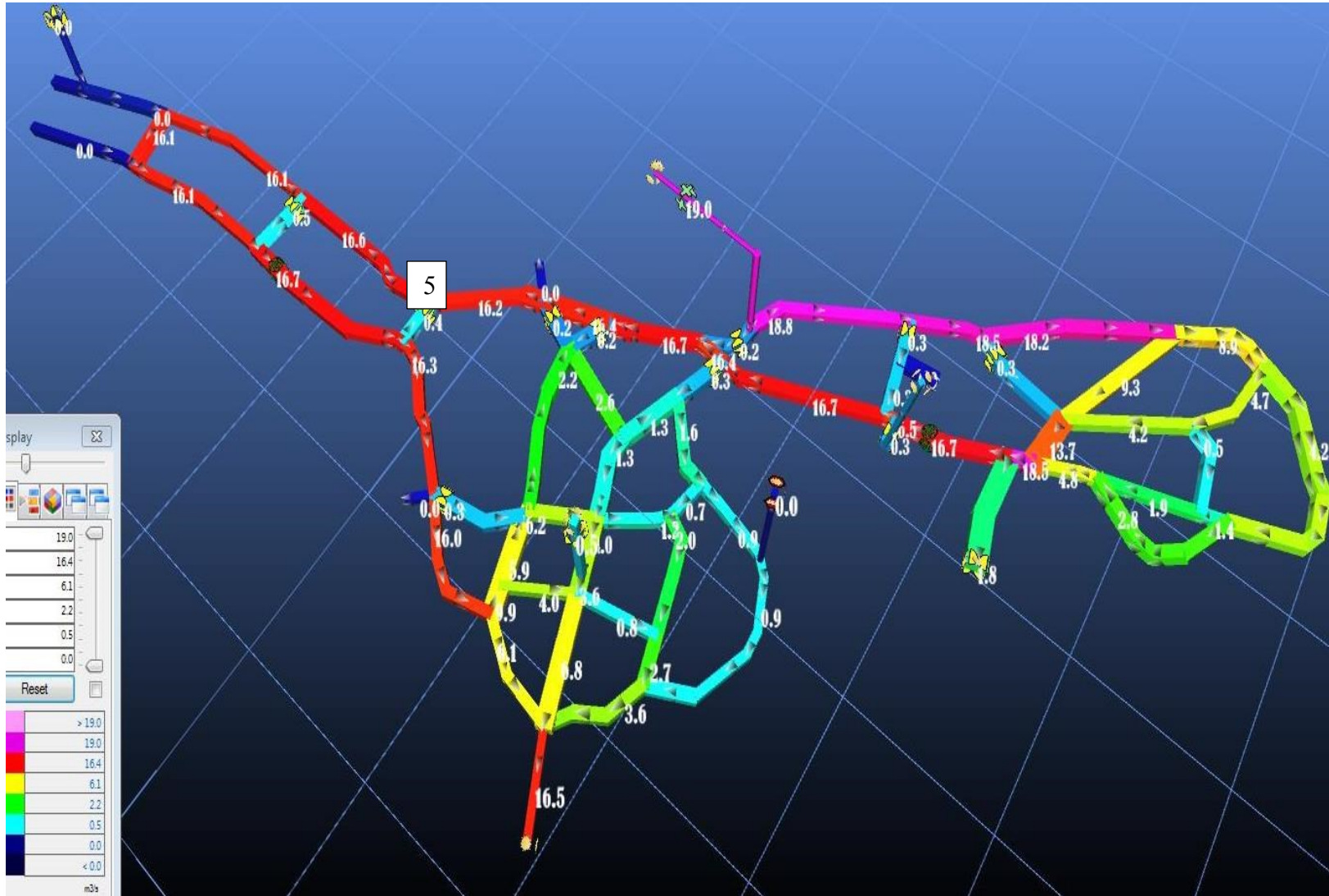

Figure 5.15 Main fan, west and east booster fan at blade set 3 results

**5.2.4.3. Main fan, west booster and east booster fan at blade Setting 5.** The combination of the main mine fan and both booster fans produced the most pronounced effect of the use of booster fans on leakage and recirculation. The eastern booster fan introduced recirculation to the stopping that is closest to it while the western booster fan introduced leakage in the west end part of the mine. Figure 5.16 shows the effect of booster fan use in the eastern part of the mine while Figure 5.17 shows the effect of booster fans on the west bloc of the mine. This effect from Ventsim Visual simulation does not coincide with that observed during experimental analysis as seen in Table 4.7. The experimental analysis showed results with less recirculation paths than shown by simulation. Rather, the simulated results are similar to those observed when the booster fans are used individually and in series with the mine main fan.

Between all the scenarios and blade angle settings observed, this combination at this blade setting shows the most visibly alternation in behavior of leakage and recirculation. Recirculation and leakage observed affects all parts of the mine as compared to the use of a single booster fan which affects mostly the stoppings closer to its location. An observation that was not made during the experimental analysis is that shown in Figure 5.16 which shows the leakage of airflow into the mine through the Kennedy Machine door. The depression in pressure created behind the booster fan forces air into the mine through the door.

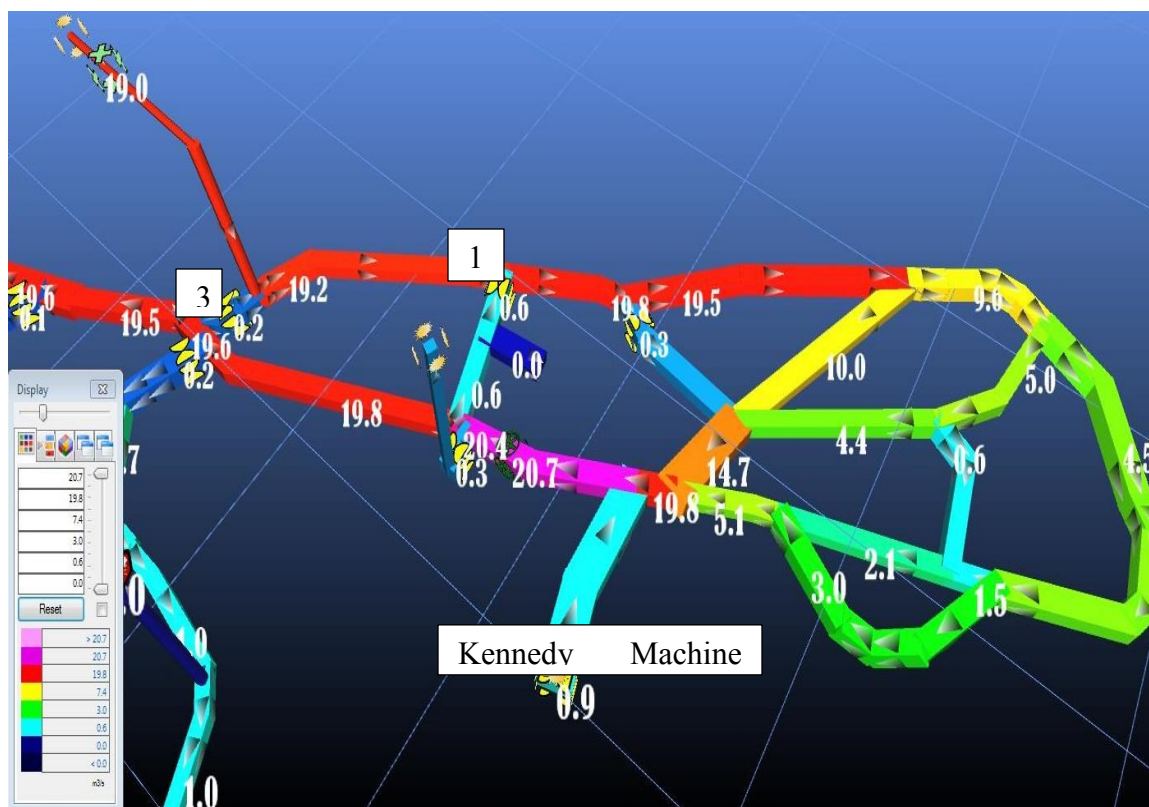

Figure 5.16 Recirculation and leakage on the east part of the mine

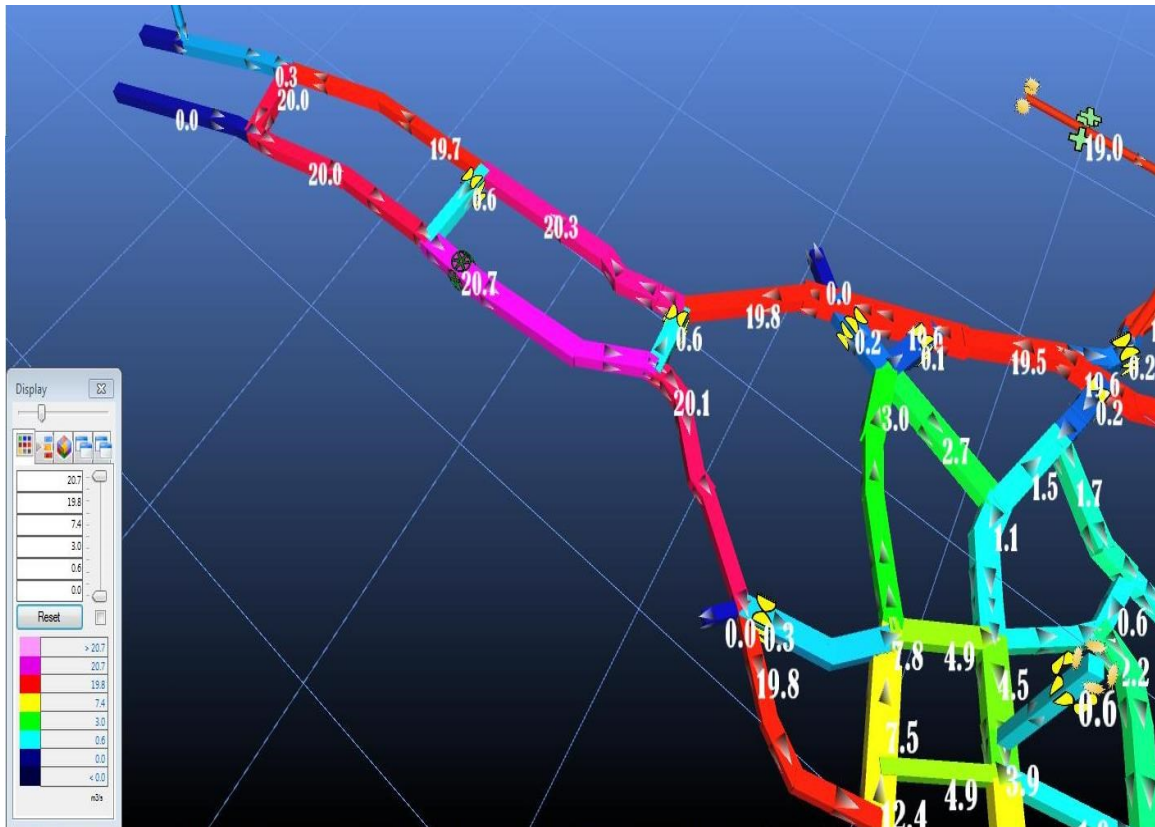

Figure 5.17 Recirculation and leakage on the west part of the mine

### 5.3. CONCLUSIONS TO SECTION

The objective of this Section was to simulate the ventilation system changes that are brought about by the use of booster fans as it happens in an actual mine. Objectively, the Ventsim Visual model simulations were to either credit, discredit or enhance the experimental analysis results. The following conclusions can be drawn from the simulated observations;

- The anomaly observed at stopping 2 during experimental analysis is not reproduced in the simulation results. The anomaly in experimental analysis is not considered wrong as it appears in all measurements but the conditions that force its outcome cannot be inputted into Ventsim Visual. Theoretically, the simulated

results are the ideal results at stopping 2 as no other pressure is introduced before that stopping

- Ventsim Visual simulated results confirm the hypothesis made in experimental analysis of airflow leakage from stopping 3 that is adjacent to the main intake shaft which could not be proven experimentally. The recirculation into the intake airway and leakage into the return can also be proven by simulation.
- The simulation confirms the experimental analysis results for scenarios 1, 2 and 3 but offers different results for scenario 4. Scenario 4 shows more recirculation paths in Ventsim Visual simulation than that observed in the experimental analysis. Lower blade angle settings for both the east and west booster fans do not introduce recirculation as compared to higher booster fan blade angles.
- It is also evident that lower booster fan blade angles lead to underutilization of the booster fan while higher (blade angle setting 5) lead to the mismatch of the booster fan and the ventilation system.
- Leakage through the Kennedy door into or out of the mine was also observed during simulation. This behavior cannot be observed during experimental analysis as they were not possible to determine experimentally.

## 6. CONCLUSIONS AND RECOMMENDATION

### 6.1. CONCLUSIONS

As mining continues to expand and go deeper, the need for improved and efficient ventilation increases. With all this increase in ventilation needs due to underground mine expansion, operating costs also increase. This increase is mostly associated with the need to increase the required fan pressure and air quantity to overcome increased resistance. There is also increased leakage as the growth or expansion of the mine generates more leakage paths. This leakage will need to be overcome by increased pressure and air quantity. All these have encouraged the use of booster fans and other auxiliary ventilation devices in underground mines. The use of booster fans comes with increased safety hazards associated with leakage and recirculation. The objective of this study was to investigate the effect of the use of booster fans on leakage and recirculation.

The experimental analysis concluded that the use of booster fans affects the behavior of leakage and recirculation based on the location of the leakage or recirculation paths relative to that of the booster fan in use. It was observed that higher leakage rates occurred at the stoppings that were furthest from the booster fan in use due to the increased pressure differentials across stopping as the distance from the operating booster fan increases. The west booster fan creates the highest leakage rate at the eastern part of the mine while the east booster fan creates the highest leakage rates at the western part of the mine when both are used separately. Using both the east and west booster fans means the pressure differentials observed when a single fan is used are offset and thus resulting in uneven distribution of leakage rates. The combination of the both booster fans produced the highest leakage rates compared to scenarios 1 and 2 which utilized a single



booster fan at a time. When compared to the use of the mine main fan only scenario, the east booster fan had the most pronounced effect on leakage than the west booster fan. This is caused by the locations of each fan; the east booster fan is located in the intake fresh airway while the west booster fan is located in the return airways and this difference constitutes to the pressure differentials across the each stopping.

Recirculation was observed at stopping 2 and a conclusion was drawn that this was not a result of the use of booster fans. This is because all fan combinations and blade angle settings showed the same recirculation path at this stopping including the use of the mine main fan only. At lower booster fan blade angle settings 1, and 2, there is no recirculation observed for all the testing scenarios. Booster fan blade angle setting 3 for all the booster fan combinations introduced minimal recirculation while the higher booster fan blade settings 4 and 5 introduced more pronounced recirculation. Recirculation is most concentrated to the stoppings that are closest to the booster fan that is being used. The recirculation that is caused by the east booster fan is concentrated at stoppings 1 while that caused by the west booster fan is concentrated at stopping 4 and 5. It is therefore fair to conclude that the use of booster fans affect the behavior of recirculation based on the location of the recirculation path relative to the booster fan in use and the booster fan blade angle setting used.

Ventsim Visual simulation concluded that the recirculation observed at stopping 2 during experimental analysis is an anomaly not reproduced in the simulation results. The anomaly in experimental analysis is not considered wrong as it appears in all measurements but the conditions that force its outcome cannot be inputted into Ventsim Visual. Theoretically, the simulated results are the ideal results at stopping 2 as no other

pressure is introduced before that stopping. The simulation also helps enhance the results obtained during experimental analysis as the leakage and recirculation paths which were impossible to measure were clearly defined in the simulation outcome. Airflow behavior at stopping 3 is clearly defined and from the simulated results.

The simulation confirms the experimental analysis results for scenarios 1, 2 and 3 but offers different results for scenario 4. Scenario 4 shows more recirculation paths in Ventsim Visual simulation than that observed in the experimental analysis. Lower blade angle settings for both the east and west booster fans do not introduce recirculation as compared to higher booster fan blade angles. All these observations lead to the same conclusion from the experimental analysis that the booster fans affect the behavior of leakage and recirculation with regards to location of leakage and recirculation paths relative to the booster fan in use and the booster fan blade angle setting. The objective of proving the experimental results was satisfied as this was achieved.

To limit the potential for system leakage and recirculation, the location of a booster fan in a ventilation system should be thoroughly evaluated. The fan should be located so that pressures in the intake airways are higher than pressures in the return airways and the formation of neutral points should be avoided. It is important to note, as the mine develops further from a booster fan, the section resistance increases and the potential for recirculation decreases. Also, the sizing of the booster fan is important. The efficient operating parameters of a booster fan should be investigated to avoid underutilizing booster fans or over matching booster fans with the ventilation system in use. The system leakage and recirculation is also strongly dependent on the quality of the ventilation control devices such as stoppings, doors and regulators. Taking care of and

maintaining stoppings, regulators and doors can reduce the amount of and potential for leakage and recirculation. Managing system leakage and recirculation is not only beneficial to the safety standards of the mine but also benefits the economic standing in regards to ventilation. Reducing leakage results in reduced energy costs needed to push more ventilating air into the underground workings to accommodate that lost through leakage.

From the research, the location of the booster fan has the most influence on the behavior of leakage than the booster fan blade angle settings. The east located booster fan had the most overall influence.

## **6.2. RECOMMENDATIONS**

This study concluded that higher booster fan blade angle settings and booster fan location were responsible for the recirculation observed in an underground mine but that should not be the standard for selecting to use booster fans. More research is needed to determine the effects of booster fan on safety and economic aspects in an underground mine. The effect of ventilation control devices on the potential and amount of leakage and recirculation should also be investigated before the resolution to use booster fans is made.

The ventilation system investigated in this thesis is based on forcing ventilating air into the underground workings, it would be ideal to investigate the same exercise on an exhausting ventilation system. The Missouri S&T Experimental Mine is currently undergoing a system upgrade that will turn it into an exhausting system and allow for such a recommendation to be investigated. The current ventilation system exhausts air

from the mine entrance, which is not an ideal system. The determination of the best location for the booster fans after the system upgrade is also important as it would help in curtailing leakage and recirculation.

## BIBLIOGRAPHY

1. Anon, 2010. "Kennedy Steel Stoppings," Jack Kennedy Metal Products, USA.
2. Bakke, P., Leach, S. J., and Slack, A., 1964, "Some Theoretical and Experimental Observations on the Recirculation of Mine Ventilation," *Colliery Eng.*, No. 41, pp. 471-477.
3. Briggs, H. (1931) "The Underground Leakage of Air: Investigation of the Porosity Coefficient," *Trans. Inst. Min. Engrs.*, Vol. 82, pp. 111-121.
4. Burnett, R.L. and Mitchell, D. 1988. "The Safe Use of Controlled Recirculation Techniques in the Ventilations of United Kingdom Coal Mines." *Proc. of the 4<sup>th</sup> International Mine Ventilation Congress.*
5. Burrell, R.A., and Bennett S.C., 1995. "Recent developments in the ventilation of coal mines." *Coal International*, Vol. 243, No. 4, Jul., pp. 147-150.
6. Burton, C.R., Plenderleith, W., Stewart, M.I., Pretorius, B.C.B., Holding, W. "Recirculation of air in the ventilation and cooling of deep gold mines." 3rd Int. Mine Vent. Cong Harrogate, 1984, I.M.M. pp291-299.
7. Calizaya, F. 2009. "Guidelines for installing and operating booster fans in underground mines." *Proceedings of the Ninth International Mine Ventilation Congress.* New Delhi, India: Oxford and IBH.
8. Calizaya, F., Karmawan, K., and K.G. Wallace, K.G., 2001, "PT Freeport DOZ mine ventilation system," *Proceedings of the 7th International Mine Ventilation Congress*, Cracow, Poland, pp. 949-953.
9. Calizaya, F. M.J. McPherson, and P. Mousset-Jones 1987. "An Algorithm for Selecting the Optimum Combination of Main and Booster Fans in Underground Mines," *Proceeding, 3rd U.S. Mine Ventilation Symposium*, Littleton, CO: SME.
10. Calizaya, F., M.J. McPherson, and P. Mousset-Jones. 1988. "Guidelines for Implementing a Booster Fan monitoring and control system in coal mines," *Proceedings of the 4th US Mine Ventilation Symposium*, UC Berkeley, Berkeley, CA, pp. 382-391.
11. Calizaya, F. and Stephens, M., 2006, "Studies of leakage flow in the U.S. underground coal mines," *Proceedings of the 11th U.S./North American Mine Ventilation Symposium*, Penn State University, University Park, PA, pp. 599-606.
12. Calizaya, F., Stephens M, Gillies A. D. S., "Utilization of Booster Fans in Underground Coal Mines," *SME Annual Conference*, March 2010, Phoenix, Arizona.

13. Coetzer, W.J.J., 1985, "Use of a sealant paint to seal leakage through ventilation stoppings constructed from precast concrete bricks," *Journal of the Mine Ventilation Society of South Africa*, January 9-11.
14. Falkie, T. V., 1958, "A Study of the Effects of Reynolds Number on Friction Factor in Mine Airways," unpublished report, Penn. State Univ., University Park, PA.
15. Gillies, A. D. S., Calizaya, F., Wu, H. W., and Slaughter, C., 2010. "Booster Fans – Some Considerations for their Usage in Underground Coal Mines," *Proceedings, 13th US Mine Ventilation Symposium*, Eds S. Hardcastle and D. L. McKinnon, Sudbury, Ontario, June 2010 pp511-518.
16. Gillies, A.D. S and Calizaya, F, 2012 "Use of Underground Booster Fans in Foreign Prominent Coal Mining Countries Compared With The Ban in The United States," *Proceeding, 14<sup>th</sup> US Mine Ventilation Symposium*, June 2012.
17. Greenwald, P.H, Howarth "Recirculation of Air and Mine Gas Caused by Auxiliary Fans as Used in Coal Mines," New York meeting, February, 1928.
18. Hartman, L. H, "SME Mining Engineering Handbook, Volume 1," pp 1090, Seeley W. Mudd Memorial Fund of AIME, Society of Mining, Metallurgy, and Exploration (U.S.) 1992.
19. Hartman, H.L., Mutmansky, T.M, Ramani, R.V., and Wang, Y.J., 1997, "Mine Ventilation and Air Conditioning," Third Edition, New York: John Wiley and Sons.
20. Holdsworth, J.F., Pritchard, W.F., Walton, H.W., (1951) "Fluid Flow in Ducts with a Uniformly Distributed Leakage," *Brit. J. Applied Phys.*, Vol. 2, November, pp. 321-324.
21. Jarrett, S.M., Brake, E.L., Riley, R.E., and Wilson, R.V. 1972. "Final report of major mine fire disaster Sunshine Mine," Sunshine Mining Company, Kellogg, Shoshone County, Idaho.
22. Javanbakht, A.H., "Utilization of Booster Fans in Underground Mines," Master's Thesis, Missouri University of Science and Technology, 2013.
23. Jones, T. M., 1987, "The Application of Controlled Recirculation to Mine Ventilation Planning," Ph.D. thesis, University of Nottingham, UK.
24. Kawenski, E.M, and Mitchell, D.W., 1963, "An evaluation of stopping construction," *Mining Congress Journal*, September, pp. 57-61.
25. Kawenski, E.M., Mitchell, D.W., Bercik, G.R., and Frances, A. (1965). "Stoppings for Ventilating Coal Mines." Pittsburgh, PA: U.S. Department of the Interior, Bureau of Mines, RI 6710.

26. Kawenski, E.M. and Mitchell, D.W. (1966) "Evaluation of Materials for Ventilation Structures," Min. Cong. J., Mar., pp. 49-53.
27. Kharkar, R., Stefanko, R., and Ramani, R.V, 1974, "Analysis of Leakage and Friction Factors in Coal Mine Ventilation Systems," Special Research Report Number SR-99, Pennsylvania Department of Commerce.
28. Krog. R. B, "Selection of Underground Booster Fans," Proceedings of the North American/Ninth US Mine Ventilation Symposium, Kingston, Canada, 8-12 June 2002.
29. Lawton, B. R, 1933, "Local Cooling Underground by Recirculation," Trans. Inst. Min. Engr., Vol. 85, pp. 63-67.
30. Lauriski, D. And Yang, B. "Is the System of Mine Safety and Health in the US Broken," Mining Engineering, SME, July 2011, pp77-82.
31. Leach, S. J., 1969, "Recirculation of Mine Ventilation Systems," Min. Engr., Jan., pp. 227-236.
32. Longson. I, Tuck. M, 1989. "Improving mine ventilation," Mining Magazine, October 1989. pp 313-315.
33. Mancha, R (1942) "Effects of Underground Stopping Leakage upon Mine Fan Performance," Trans. AIME, Coal Division, Vol. 149, 4 pp.
34. Marshall, L.K. "Auxiliary Ventilation in Underground Mines," Engineering Fundamentals Series.
35. Martikainen, A.L., and C.D. Taylor. 2010. "Breaking the Ice on the Booster Fan Dilemma in US Underground Coal Mines," Mining Engineering 62(10): 47-53, Denver, Colorado, USA.
36. McPherson, M.J., 1993. "Subsurface Ventilation," London: Chapman Hall.
37. Moll, A.T., and Lowndes, I.S., 1994. "An approach to the optimization of multi-fan ventilation system in U.K. coal mines." Journal of the Mine Ventilation Society of South Africa, January: pp. 2-18.
38. Peascod, W. and Keane, A (1955) "The Effect of Leakage on Mine Ventilation," Colliery Engineering, Vol. 32, May, pp. 207-211.
39. Pickering, A.J and Robinson, R., "Application of controlled recirculation to auxiliary ventilation systems and mine district circuits," 3rd Int. Mine Vent.Cong. Harrogate, I.M.M. 1984, pp315-322.

40. Raja V. Ramani, 1993, "Current issues in US mine ventilation." 6th US Mine Ventilation Symposium, Salt Lake City, UT, June 21-23.
41. Richardson, M.A., Gilbride, L. Adair, L., and Glasson, M.W., 1997, "Ventilation planning at the Aberdeen mine," Proceedings 6th Int. Mine Ventilation Congress, Pittsburgh, PA, pp. 33-38.
42. Robinson, R., 1972, "Trials with a Controlled Recirculation System in an Advance Heading," Symposium on Environmental Engineering in Coal Mining, Paper No.9, pp. 73-82.
43. Robinson, R., 1989. "The use of booster fans and recirculation systems for environmental control in British coal mines." Proceedings of the 4th U.S. Mine Vent Symp. SME, Littleton, CO, pp. 235-242.
44. Robinson, R., Harrison, T., "Controlled Recirculation of air at Wearmouth Colliery," The Mining Engineer, Vol. 146, No. 308.
45. Sartain L.T, Stevenson, W.J "Jim Walter Resources, INC.'s booster fan proposal – A case study." Proceedings of 4th US mine ventilation symposium.
46. Saxton, I., 1986. "Coal Mine Ventilation from Agricola to the 1980's." Part VIII, Mining Eng., Gullick Dobson Ltd., London, pp. 395-405.
47. Smith I.H, 1927, "Use and dangers of Booster and Auxiliary Fans applied to coal mine ventilation," New York Meeting, February.
48. Singh, A.K., Ahamad, I., Sahay, N., and Varma, N.K., 1999, "Air leakage through underground ventilation stoppings and in-situ assessment of air leakage characteristics of remote filled cement concrete plug by tracer gas technique," Journal of the Mine ventilation Society of South Africa, July/September, pp. 102- 106.
49. Stephens, M. "Laboratory and numerical modeling used to characterize leakage," Master's Thesis, University Of Utah May 2011.
50. Tien J. "Air Leakage Costs." Coal Age Sep 1996, Vol 101, Issue 9, pp. 88.
51. Tien, J.C. 1981. "Metal Stoppings Reduce Air Leakage," Coal Age, Apr., pp. 74-77.
52. Tien J, Wang J.Y, "An Analysis of Controlled District Recirculation System." SME Annual Conference, March 1995, Denver, CO.
53. Title 30 Code of Federal Regulations. 30 CFR 75.302. 12/2010, USA.
54. Ventsim Visual, 2012, Ventsim Visual User Guide, Ventsim Company.



55. Vinson, R.P., Thimons, E.D., and Kissell, F.N., 1977, "Brattice Window Method for Measuring Leakage through Mine Stoppings," RI 8240, US Bureau of Mines.
56. Wempen J. M, "Characterization of Air Recirculation in Multiple Fan Ventilation systems," Master's Thesis, University Of Utah May 2012.
57. Wempen, J. M., Calizaya, F., Peterson, R. D. and Nelson, M. G., "Evaluating the Use of Booster Fans in Two Underground Coal Mines." SME Annual Conference, 2011, Society of Mining, Metallurgy and Exploration, Denver, Colorado, USA.
58. Wu, H. W., Gillies, A.D.S., Nixon C,A., "Cost analysis of Controlled Partial Recirculation of Mine Ventilation Air at Mount Isa Mines," Proceedings of the 7<sup>th</sup> US Mine Ventilation Symposium, Kentucky, Jun 5-7, 1995, pp 15.

## VITA

Koziba Feledi graduated with a diploma in Mining Engineering from University of Botswana in 2008 and then went on to graduate with a B.S in Mining Engineering and a secondary major of B.A in Economics in 2012 from Missouri University of Science and Technology. He then returned to Missouri University of Science and Technology in 2013 to pursue a M.S in Mining Engineering, where he has held positions of teaching assistant and graduate research assistant while working on the NIOSH booster fan project.